



# SFCO

*www.surveying.com*

**SURVEYING ACCESSORIES CATALOG**



*Spring* **2011**

## Product Contents

### GPS Accessories

Heavy-Duty GPS Antenna Tripods.....	5
Heavy-Duty GPS.....	5
Tripod Bag.....	5
Standard Fixed-Height GPS Antenna Tripod.....	6
Extra Large Tripod Bag — #8153-10-ORG.....	6
Graduated Collapsible GPS Antenna Tripod.....	6
GPS Antenna Tripod Bag — #8154-00-ORG.....	6
Adjustable-Tilt, Stainless Monument Adapters.....	7
40-Minute Leveling Vial.....	7
Stainless Steel Pipe Thread Masonry Adapter.....	7
Masonry Mount Adapter.....	7
Antenna Mast Adapter.....	7
All-Terrain Rover Rod 'Big Wheel'.....	8
6-Foot Snap-Lock.....	8
Radio Antenna Pole.....	8
GPS Rover Rod.....	8
Hard Shell Case.....	8
Satellite Stick XL - Sectional 2-Meter GIS Pole.....	8
Snap-Lock Rover Rods.....	8
Fiberglass Model.....	8
Two Piece Carbon Fiber Rover Rod.....	9
Two Piece Aluminum Rover Rod.....	9
Telescoping GPS Carbon Fiber Rover Rods with Locking Pin.....	9
GPS Adapters.....	9
GPS Quick Disconnect Adapter (Stainless Steel).....	9
GPS Quick Release Adapter (Stainless Steel).....	9
Triple Mag Mount.....	9
Quick Release Adapter for Rover Rods.....	9
Single Mag Mounts.....	9
8-minute Vial Assembly for 1.25-inch OD Poles.....	10
Snap-Lock Pole System Bag.....	10
2-Meter Height Pin.....	10
HI 2-Meter GPS.....	10
Pocket Rod/Tape.....	10
Switchable Kelly Magnet Mount.....	10
10-Meter RTK Radio Antenna Pole.....	10
GPS Antenna Platform.....	10
Pole Bracket Kit for Pathfinder ProXRT.....	11
Antenna Bracket.....	11
Radio Antenna Bracket for Tripod.....	11
Antenna Mast Bracket.....	11
Radio Antenna Mast Assembly.....	11
Includes carry bag!.....	11
Radio Antenna Tripod with Antenna Mast.....	11
GPS Truck Door Bracket.....	12
3-Inch Extension Kit.....	12
Topo Shoe Adapter.....	12
Interior Controller/Collector Bracket System.....	12
Ball-and-Socket Link.....	13
Open Clamp Pole Brackets and Cradles.....	14
ATV Pole Bracket System with Antenna Bar.....	14
ATV Pole Bracket System.....	14
Data-Max Data Collector Holders.....	15
Data-Max Collector Cradles with Dash Mount.....	15
Data-Max Collector Cradles.....	15
Data-Max Collector Cradles with Pole Mount.....	15
Data-Max Pole Mount.....	15

### Vials and Levels

The Heads-Up Level for Antenna Tripod.....	16
Heads-Up Rod Level.....	16
Standard Rod Level.....	16
The Original	
Heads-Up Level.....	16
Pole Peg Adjusting Jig.....	16
Snap-On Rod Level.....	16

### Robotics Accessories

360° Robotic Prism Assembly.....	17
Adapter Kit for Topcon RC2 and RC3 Users.....	17
Prism Height Adapters.....	17
One-Section Carbon Fiber Robotics Pole.....	17
Two-Section Carbon Fiber Robotics Pole.....	17
Padded System Bags.....	17
Short Padded Bag.....	17
Long Padded Bag.....	17
12-inch Bipod.....	17
Rodrest.....	17

### Specialty Prism Poles

Non-Conductive Fixed-Height Prism Pole.....	18
---	----

Carbon Fiber Pole.....	18
QLV Pole for Robotics Applications.....	18
Swiss-style TLV Prism Pole.....	18
Mini Stakeout.....	18
Mini Pole.....	18
Mini Rod.....	18
Swiss-style Twisting Lock Prism Pole.....	18
Geodimeter Style Telescoping Prism Pole.....	19

### Telescopic Quick Change Prism Poles

Quick Change Poles.....	20
Quick Change Adapters.....	20

### TLV and Twist-Locking Telescopic Prism Poles

One-Section TLV Prism Poles.....	21
Two-Section TLV Prism Poles.....	21
Three-Section Twisting Lock Prism Poles.....	21

### QLV Telescopic Prism Poles

One-Section QLV Prism Poles.....	22
Two-Section QLV Prism Poles.....	22
Universal Pole Bag.....	22

### Quick-Release Telescopic Prism Poles

Prism Pole Hard Shell Case.....	23
One-Section Quick-Release Prism Poles.....	23
Two-Section Quick-Release Prism Poles.....	23

### Compression Lock Telescopic Prism Poles

One-Section Compression Lock Prism Poles.....	24
Two-Section Compression Lock Prism Poles.....	24
Three-Section Compression Lock Prism Poles.....	24

### Ultralite Telescopic Prism Poles

Fiberglass Ultralite Poles.....	25
---------------------------------	----

### Crain Telescopic Prism Poles

Crain Carbonlite (Carbon Fiber) Prism Poles.....	26
Crain Alumilite (Aluminum) Prism Poles.....	26

### Basics Plus Prism Poles

TLV and Twist-Locking Prism Poles.....	27
Compression-Locking Prism Poles.....	27
Basics Plus Surveyors Kits.....	27

### Prism Pole Accessories

Laser Detector Mount.....	28
Adjustable Offset Bar.....	28
Offset Pole Holder Kit.....	28
Stedi-Rest.....	28
Center Punch Point.....	28
Aluminum, Carbon Fiber, Fiberglass Pole Extensions.....	29
Basics Plus Range Poles.....	29
10-Minute Level Vial Conversion Kit.....	29
Topo-Boot.....	29
Topo Shoe & Point Combo.....	29
Heavy-Duty Range Poles.....	29
Pole Bag.....	29

### Prism Pole Bipods and Tripods

The Original Thumb Release Bipod.....	30
Carbon Fiber Thumb Release Bipod.....	30
Thumb Release Mini Bipod.....	30
Carbon Fiber Quick Lever Bipod.....	30
Gardner Engineering Rodrest.....	31
Alligator Clamp Tripod.....	31
Quick Lever Head Bipod.....	31
Mini-Prism Monopod Kit.....	31
Dual Hinge Bipod.....	32
Thumb-Release Tripod.....	33
Prism Pole Bipod/Tripod Bags.....	33
Carbon Fiber Thumb Release Tripod.....	33
Simple Tripod with 12-Inch Legs.....	33

### 62-mm Prisms and Assemblies

Rear Locking 62-mm Premier Prism Assembly.....	35
Rear Locking 62-mm Premier Prism Holder and Target.....	35
Eclipse 62-mm Nodal Point Prism Assembly.....	36
62-mm Nodal Point Prism Assembly.....	36
62-mm Nodal Point Prism Assembly.....	36
Single Prism Tilting Assembly.....	36
62-mm Prism with Non-Tilting Holder.....	36
Premier 62-mm Prism Assembly.....	37
Standard 62-mm Prism Assembly.....	37
Tilting Triple Prism Assembly.....	37

### 58-mm Prism Assemblies

Universal Tilting Prism Assembly.....	38
---------------------------------------	----

### 25-mm Prisms and Accessories

Tilting Mini Prism System.....	39
Mini Prism System.....	39
Stakeout Mini Prism with Site Cones.....	39
Stakeout Mini Prism Kit.....	39
25-mm Stakeout Prism Assembly.....	39
Nodal Point Stakeout Mini Prism Kit.....	39
Euro-Style Prism Pole Systems.....	40
Sliding Prism and Sectional Pole Kit.....	40
Pin Pole with Sliding 25 mm Prism System.....	40
Reflector Pin Pole Kit.....	40

### 25-mm Prisms and Pin Pole Kits

Sliding 360° Prism Kit.....	41
Sliding Mini Prism Kit.....	41

### Other Prisms and Accessories

Premier 62-mm Strobe Prism Assembly.....	42
Tilting Triple Prism Holder.....	42
Standard 62-mm Strobe Prism Assembly.....	42
Non-Tilting Prism Holder.....	42

### Mining, Tunneling and Deformation Accessories

Walleye Prism System.....	43
Small, Lightweight Tilting Reflectors.....	43
Stainless Steel Quick Release Adapters.....	43
Anodized Quick Release Adapter.....	43
25-mm 'L-Bar' Mini Prism.....	43
Rebar Bolts.....	43

### Tribrachs and Adapters

European-Style Tribrachs.....	44
Laser Tribrach.....	44
Optical Plummet Twist Focus Tribrach.....	44
Fixed Tribrach Adapter.....	45
Rotating Tribrach Adapter.....	45
Horizontal Base.....	45
Tribrach Adjuster.....	45
Rotating Tribrach Adapter.....	45
Prism H.T. Adapter.....	45
Tribrach Adjusting Cylinder.....	45
Tribrach Case.....	45
Traverse Kit for 196 mm Heights.....	46
Traverse Kit for 155 mm Heights.....	46
Traverse Kit.....	47
Traverse Tribrach Adapter.....	47

### Instrument Tripods

Aluminum Tripods.....	48-49
Extra-Large Tripod Bag.....	49
Tri-Max Tripod.....	50
Tri-Max Tripod 5-Inch Points.....	50
Tri-Max Tripod Snow Plates.....	50
Tri-Max Fiberglass Elevator Tripod.....	51
Extra Tall, Fiberglass Elevator Tripod.....	51
Extra Large Tripod Bag.....	51
Portable 11-Foot Fiberglass Tripod.....	51
Premier Heavy-Duty Wood Tripod with Round Head.....	52
Premier Heavy-Duty Wood Tripod with Round Head and Twisting Lock Legs.....	52
Premier Heavy-Duty Wood Tripod with Round Head and Quick Clamp Legs.....	52
Tripod Bag.....	53
Tripod Hard Shell Shipping Case.....	53

### Instrument Tripod Accessories

Sta-Level Feet Tripod Stabilizers.....	54
Tilted Tripod Bracket.....	54
Rotating Tripod Bracket.....	54
Tripod Collector Bracket.....	54
Tripod Stabilizer.....	54
Tripod Adapters.....	54
Tripod Hook Brackets.....	54
Tripod Bracket.....	54
Tripod Laptop Bracket.....	54

### Instrument Tripod and Scanner Accessories

Tri-Max Tri-Dolly.....	55
Omnidirectional Scanner Target.....	55

Continued on page 83.

## Carbon Fiber 2-Position Snap-Lock Rover Rod

#5128-24

SECO Snap-Lock rover rods are faster to set up and more user friendly compared to traditional two-piece, screw-together rods.

Features include one-piece design and two locking systems for stability, the snap-lock prevents slippage and the compression lock centers the telescopic inner pole and maintains straightness.

These lightweight rods come with a 40-minute vial.

This model telescopes and locks at 1.8 or 1.6 meters.

Weighs 1.60 lb (0.73 kg)



Page 8

## Claw Cradle Accessories for Leica Viva CS10/CS15

#5200-15 — Ball-and-Socket Combo w/ Pole Clamp  
#5200-15-050 — Bracket

Designed to limit pressure so over-tightening cannot occur, the Claw™ Pole Clamp fits 1.25-inch poles.

The Claw cradle, designed for the Leica Viva, with 1-inch Ram Ball works with all RAM 1-inch accessories.



Page 13

## Basics Plus Surveyors Kits

#5280-01 — With Dual Grad Prism Pole  
#5280-02 — With Metric Grad Prism Pole

SECO's Basics Plus Surveyors Kits come with one 62 mm prism assembly, one prism pole, and one thumb release bipod, making this package a great introductory kit.

Choose a kit with a graduated prism pole of your choice.



Page 27

## Center Punch Point

#5194-10

The #5194-10 fits all poles or products with male 5/8 x 11 threads.

The hardened steel point will mark all metal and non-metal surfaces. It leaves a small but distinct 'center mark' that is the same as the center line of your pole or prism.

Just push down until it clicks and release.

It features a hex body shape for easy installation/removal.

Measures 0.472 ft (144 mm)

Weighs only 0.2 lb (0.09 kg)



Page 28

## Sliding Mini Prism Kit

#5910-07M — Metric, -17.5 Offset (shown)  
#5910-07F — Feet, -17.5 Offset  
#5910-08M — Metric, -30 Offset  
#5910-08F — Feet, -30 Offset

These prism holders allow 'non-zero' prism offsets to 'slide' and are available in -17.5 mm or -30 mm offsets.

They come equipped with a 25 mm silver-coated mini prism and height scales built into the holder frames.

They have a sliding range of 0.50-foot (15 cm).

The mini prism assembly can be removed and used normally for other jobs.

Three 1-foot (30 cm) extensions and one 0.50-foot (15 cm) extension are included.

They feature stainless steel points and 20 minute adjustable circular vials.

The #5910-07 and #5910-08 are precision machined from aluminum and stainless steel parts.

Weighs 3 lb (1.4 kg)



Page 41

## Sliding 360° Prism Kit

#5910-20 — Metric  
#5910-21 — Feet (shown)

The prism assembly on this new 360° prism kit slides on 9-mm-diameter solid steel pin poles.

The assembly is composed of seven 12.7-mm-diameter silver-coated mini prisms in a 360° configuration.

It features a +2-mm offset and a 40-minute adjustable circular vial.

A clamp screw locks the prism assembly anywhere on the pole.

Weighs 1.76 lb (0.80 kg)



Page 41



## Tri-Max Tri-Dolly

#90555

The Crain Tri-Dolly™ speeds up data collection and makes moving your instrument setup quick, no need to break down to get to your next measuring location. It's ideal when working on hard surfaces in buildings or plants and will work with all common heavy duty tripods.

Weighs 14.4 lb (6.54 kg)

Page 55

## European-Style High-Precision Tribrachs

#2152-06-BLK — Tribrach with Optical Plummet  
#2153-06-BLK — Non-Optical Plummet Tribrach

The #2152-06-BLK and #2153-06-BLK are intended for use with precise, high-accuracy and heavy total stations and 3D laser scanners where the systems are likely to produce greater torque and thus greater stress on the tribrach.

The quality materials and components used in the #2152-06-BLK and #2153-06-BLK meet the highest standards. In addition to the precise manufacturing process, the error in angle measurement (hysteresis) is under 3 cc.

Weighs 1.5 lb (0.70 kg)



Page 44

## Traverse Kits for 155 and 196 mm Heights

The #2159-04-BLK Traverse Kit is preset to a 155 mm height making it compatible with Nikon NIVO™ Series Total Stations.

The #2159-03-BLK Traverse Kit is preset to a 196 mm height making it compatible with the Trimble® S6 and the Spectra Precision Focus 30 instruments. It can also be adjusted for taller instruments ranging from 196 mm to 216 mm heights.

Weighs 9.95 lb (4.51 kg)



Page 46

## Heavy-Duty GPS Antenna Tripods

#5119-10-FLY — Standard Model, Fluorescent Yellow or Yellow

#5119-11-FLY — with Precise Adjusters, Fluorescent Yellow or Yellow

#5119-12-FLY — with Precise Adjusters and Dual Points, Fluorescent Yellow or Yellow

This tripod is similar to the popular SECO 5119-00-FLY (next page), but stronger. This heavy-duty tripod features a 6-inch-OD, round head which easily holds lasers or robots.

Its larger telescoping legs (1.25- to 1.50-inch diameters) feature adjustable handle bolts on the leg pivots creating greater stability. No tools are needed to set the leg pivot tension!

The #5119-11-FLY has the same standard features as the #5119-10-FLY but includes precise adjusters to make centering the 8-minute vial easier. The adjusters provide fine leg extension, a range of  $\pm 0.25$  inch from the center line. It's like having leveling screws for a tripod!

The #5119-12-FLY is identical to the #5119-11-FLY with the addition of double leg points (shown at right). Dual points create more bite in the ground and minimize the chance for twisting. Double points are useful with angle measuring instruments such as robots.

All three models are suitable for GPS and machine-control applications. Colors available: fluorescent yellow (FLY) or yellow (YEL).

Each weigh approximately 20 lb (9.07 kg)

The #5119-11-FLY features precise leg adjusters

Large 6-inch-diameter head

The #5119-12-FLY features the precise leg adjusters and double leg points

Adjusts to 2, 1.8, and 1.5 m and collapses to 139.7 cm (55 inches)!

## Heavy-Duty GPS Tripod Bag

#8154-12-ORG

Make sure your heavy-duty SECO GPS Tripod is protected in this extra-tough Tripod Bag.

This bag features heavy-duty Cordura® material and Rhinotek™ end pieces for superior strength and longevity. It includes a shoulder strap.

Measures: 8 inch ID x 56 inches. Weighs 1.8 lb (0.82 kg)



## Standard Fixed-Height GPS Antenna Tripod

#5115-00-FLY — Fluorescent Yellow  
#5115-00-YEL — Yellow

*The Original!*

This tripod has a fixed-height, 2-meter center staff that rotates 360° for calibrating the 8-minute vial. It also features a removable 5/8 x 11 adapter, and an on-board compass.

The extendable tripod legs and the pole are electrostatically powder painted and include replaceable points. The aluminum hardware is anodized black. Weighs 15 lb (6.8 kg)



Note: GPS tripod bags are designed to hold the tripod without the point on the center pole to prevent damage to the pole.

### Extra Large Tripod Bag — #8153-10-ORG

The bag features a full-length zipper and shoulder strap.  
Measures: 82 x 9 OD inches (208.28 x 22.86 OD cm)



Tech Tips available  
at [www.surveying.com](http://www.surveying.com)

## Graduated Collapsible GPS Antenna Tripod

#5119-00-FLY — Fluorescent Yellow  
#5119-00-YEL — Yellow

*The Original!*

This tripod features a collapsible center staff with twist-locking mechanism that rotates 360° for calibrating the 8-minute vial. It also features quick release and twist-locking mechanisms on the legs.

It is dual graduated and adjusts to three heights: 2 m, 1.8 m, and 1.5 m. It collapses to 50 inches (127 cm). Other features include a removable 5/8 x 11 adapter, and an on-board compass.

The extendable tripod legs and the pole are electrostatically powder painted and include replaceable points. The aluminum hardware is anodized black. Weighs 15 lb (6.8 kg)



Note: GPS tripod bags are designed to hold the tripod without the point on the center pole to prevent damage to the pole.

### GPS Antenna Tripod Bag — #8154-00-ORG

The bag features a full-length zipper and shoulder strap.  
Measures: 50 x 7 OD inches (127 x 17.78 OD cm)

CORS, Co-op CORS and private GPS network reference stations are being put together all over. To make the set up simpler SECO now manufactures CORS monument adapters that fit easily to threaded pipe or mount to masonry. There's no need to fabricate adapters — we have a professional solution that is simple and will provide years of stability and accuracy. Choose between anodized aluminum or stainless steel, pipe-fit or masonry mount.

## Adjustable-Tilt, Stainless Steel Monument Adapters

#2072-30 — use with 1.5-inch pipe with MPT 1-1/2 x 11-1/2 TPI — Weighs 5.5 lb (2.5 kg)

#2072-31 — use with 2-inch pipe with MPT 2 x 11-1/2 TPI — Weighs 6.6 lb (3 kg)

#2072-32 — use with 3-inch pipe with MPT 3-1/2 x 8 TPI — Weighs 6.9 lb (3.1 kg)

#2072-33 — use with male 5/8 x 11 TPI — Weighs 6.2 lb (2.8 kg)

Like the adapters below, these Adjustable-Tilt Monument Adapters are a perfect, professional solution to fit between your GPS antenna and the mast of your network monument.

The adapters in the #2072-Series have 3.20-inch (8.19 cm) diameters and overall heights of 3.036 inches (7.71 cm). They include a removable brass 5/8 x 11 male stud that is adjustable in azimuth and held in location by two set screws.

The adapters are leveled by three adjusting screws with a tilt range +/- 7 degrees. The height above the pivot point to the stud shoulder is 1.37 inches (3.50 cm). The height below the brass 5/8 stud to the shoulder is 0.463 inches (1.18 cm).

The axis height is engraved on the outside of the monuments.

## 40-Minute Leveling Vial

#2072-050

This durable all-aluminum vial features 5/8 x 11 threads. Leveling a monument adapter is simple: attach, level, rotate 180° to check calibration. Weighs 0.3 lb (0.14 kg)



## Stainless Steel Pipe Thread Masonry Adapter

#2072-50

This adapter permanently connects a GPS antenna mount to a concrete (or masonry) structure. The pipe threads measure 1.5 inch x 11.5 inch NPT. The overall height of the unit is 7 inches, including the 3.5 inch length of pipe. Weighs 1.80 lb (0.82 kg)



Ideal for use with #2072-30 (shown attached). Sold separately.

## Antenna Mast Adapter

#2072-10

Use the adapter for network GPS antenna mounts.

It's easy to install, it attaches to standard 2-inch threaded pipe used as the 'mast'.

The brass rotating adapter is removable and locks in the azimuth direction.

The body is made of anodized aluminum.

Weighs 2.0 lb (0.91 kg)



## Masonry Mount Adapter

#2072-20

Use for network antenna mounts. Easy to install, just drill three, 5/8-inch holes and fill with epoxy. The brass rotating adapter is removable and locks in the azimuth direction.

The body is made of anodized aluminum with stainless steel 3/8 x 2.5-inch bolts.

Weighs 1.4 lb (0.61 kg)



## All-Terrain Rover Rod 19 x 1-5/8 Inch 'Big Wheel'

#5125-056 — Without Rod

**Add a rover top section:**  
 #5125-057-FLY — Aluminum Rod  
 #5128-052 — Carbon Fiber Rod

The Big Wheel is ideal for RTK profiling.  
 Weighs 3.8 lb (1.72 kg)



## 6-Foot Snap-Lock Radio Antenna Pole

#5139-02-FLY — Fluorescent Yellow  
 #5139-02-YEL — Yellow

The snap locks into a fixed length of 6 feet. It collapses to 41.5 inches. A 3.5-inch OD adapter (#5182-002) is included for attaching to 5/8 x 11 tripod heads.

Weighs 1.4 lb (0.62 kg)



## GPS Rover Rod Hard Shell Case

#8162-20-BLK

Store your SECO two-piece rover rod in this hard shell case and know it's protected. Measures 4 in ID x 41 in (10.16 cm ID x 104.14 cm).

Weighs 3.2 lb (1.4 kg)



## Satellite Stick XL - Sectional 2-Meter GIS Pole

#5126-10

The Satellite Stick™ XL is composed of six, 1-inch OD carbon fiber sections connected by an elastic shock cord. Collapses to 37.5 cm (1.23 ft).

Weighs 2.4 lb (1.09 kg)



Delrin Adapter #D11145

## Snap-Lock Rover Rods

These rover rods are faster to set up and more user friendly compared to traditional two-piece, screw-together rods. They feature a one-piece design and two locking systems for stability, the snap lock prevents slippage and the compression lock centers the telescopic inner pole and maintains straightness. These lightweight rods come with a 40-minute vial and are available in aluminum, carbon fiber or fiberglass to meet your job requirements.

### Aluminum Model

#5125-20-FLY-GT — GT Grads, 2.0 m Lock  
 #5125-20-FLY-GM — GM Grads, 2.0 m Lock  
 #5125-22-FLY — 2.0, 1.8, 1.6 m Locks

The #5125-20-FLY-GT and -GM (*not shown*) feature exterior graduations (10ths/100ths on the GT and metric on the GM models) and telescope and lock at 2.0 meters. The #5125-22-FLY locks at 2.0, 1.8 and 1.6 meters. Fluorescent yellow shown, other colors available.

Weighs 2.30 lb (1.05 kg)

### Carbon Fiber Model

#5128-20 — GM Grads, 2.0 m Lock  
 #5128-22 — 2.0, 1.8, 1.6 m Locks  
 #5128-24 — 1.8, 1.6 m Locks **NEW!**

The #5128-20 features exterior metric graduations, it telescopes and locks at 2.0 meters. The #5128-22 locks at 2.0, 1.8 or 1.6 meters. The #5128-24 locks at 1.8 and 1.6 meters. Carbon fiber is strong, dent resistant and has a 'zero' coefficient of expansion.

Weighs 1.60 lb (0.73 kg)

### Fiberglass Model

#5128-23 — 2.0 m Lock

This fiberglass version Snap-Lock Rover Rod is lighter than aluminum and is non-conductive. The yellow fiberglass rod telescopes and locks at 2.0 meters and collapses to 1.34 meters.

Weighs 1.65 lb (0.75 kg)



System Bag on page 10.





## Telescoping GPS Carbon Fiber Rover Rods with Locking Pin

These are designed so the GPS surveyor has all the features needed in a single rod! They're ideal for kinematic surveys and have a zero height (0 H.T.). Carbon fiber makes these 30% lighter. The included pin can set the length of the rod. TLV™ locks with 40-minute vials are standard.

### #5129-50 (Dual Graduations) or #5129-51 (Centimeter Graduations)

The 5129-50 and -51 lock at 1.8 m, 2 m and 2.2 m. The #5129-50 has dual graduations, 2 mm and 10ths. The #5129-51 is graduated in centimeters. The rods extend 2.48 m (8.14 ft) and collapse to 1.366 m (4.48 ft). Weighs 2.3 lb (1 kg)

### #5129-70 (Dual Graduations) or #5129-71 (Centimeter Graduations)

The 5129-70 and -71 lock every 20-cm starting at 1.8 m. The #5129-70 has dual graduations, cm and 0.05 ft. The #5129-71 is graduated in centimeters. The rods extend 3.57 m (11.70 ft) and collapse to 1.43 m (4.69 ft). Weighs 3.3 lb (1.5 kg)

Don't forget a case (#8160-02) for your rover!



## Two Piece Carbon Fiber Rover Rod

#5128-00

This featherweight is ideal for GPS applications. The rover rod is a fixed height of 2 meters. Includes 40-minute vial and a male 5/8 x 11 tip.

Weighs 1.42 lb (0.64 kg)

## Two Piece Aluminum Rover Rod

#5125-00-YEL

This rod features a 40-minute vial, 5/8 x 11 tip, vinyl hand grip, and replaceable steel point.

This model is also available with a quick-release adapter tip option, #5125-01-YEL. (not shown)

The quick release adapter stays fixed to the GPS antenna.

Outer grads options: GT/GM

Weighs 3 lb (1.36 kg)

Rods are also available with .625 x 1.6-in (1.6 x 4.1-cm) slots to hide the cables inside so they're protected and out of the way!  
#5125-06-YEL (aluminum)  
#5128-08 (carbon fiber)



## GPS Adapters (check for more online @ [www.surveying.com](http://www.surveying.com))

### GPS Quick Disconnect Adapter #5111-00

Adds 76.2 mm to rod length. Use with #5187-00 (left). Weighs 0.14 lb (0.06 kg)  
#5111-01 (not shown) Adds 35 mm to rod length.



### GPS Quick Release Tip #5113-012

This adapter has male 5/8 x 11 threads.  
Weighs 0.08 lb (0.04 kg)



### GPS Quick Release Adapters #5187-00

This 5/8 x 11 adds 23.8 mm to length of rod.  
Weighs 0.06 lb (0.03 kg)



### GPS Quick Disconnect Adapter (Stainless Steel) #5111-00-SS

Stainless steel version of #5111-00. Weighs 0.4 lb (0.18 kg)



### GPS Quick Release Adapter (Stainless Steel) #5187-00-SS

Stainless Steel version of #5187-00. Weighs 0.2 lb (0.09 kg)



### Quick Release Adapter for Rover Rods #5111-03

This rover rod adapter is used to make your 2-meter rod quicker to assemble and release.

The clamp screw can easily be loosened and the two sections separated. The adapter adds 60 mm to the length of the rod.  
Weighs 0.45 lb (0.20 kg)



## Triple Mag Mount

#5114-01 (shown)  
#5114-02 (w/ 5/8-in tip)

This lightweight magnetic mount system adapts easier to curved surfaces. The quick-release adapter allows for quick setups.

Weighs 3.4 lb (1.54 kg)

Magnets rated at 120 pounds pull on 1/2-inch steel plate.



## Single Mag Mounts

Both magnets have 3.5-inch diameters and weigh approximately 0.92 lb (0.42 kg) each.

5/8 x 11 tip

#5114-050

Quick release tip

#5114-051

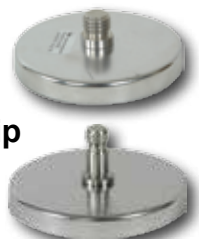

## 8-minute Vial Assembly for 1.25-inch OD Poles

#5081-052-08

This assembly is for 1.25-inch OD poles.



## Snap-Lock Pole System Bag

#8151-02-FLY

This heavy-duty bag holds a 2-meter Snap-Lock rod or pole and bipod or tripod connected. It's constructed of tough Cordura® material and Rhinotek™ ends. Measures: 5.5 inches ID x 56 inches (13.97 cm ID x 139.7 cm). Weighs 1.5 lb (0.68 kg).



## 2-Meter Height Pin

#7751-50

The height pin, with its 1-mm accuracy, is ideal for measuring antenna heights. Its dual grads are in 100ths and millimeters. The Height Pin is 6.6 feet (201 cm) long and only 16.5 inches (43 cm) when collapsed.

Weighs 0.3 lb (0.14 kg)



## Switchable Kelly Magnet Mount

#5114-052

Designed to hold on to pipes, flip the switch to release its hold on metal surfaces.

Holds up to 132.3 lb (60 kg)

Weighs 0.92 lb (0.42 kg)



## HI 2-Meter GPS Pocket Rod/Tape

#7752-00

This removable, free-standing tape measures GPS antenna height or is used as a pocket tape. The tape is a dual grad - ft/10ths/100ths and cm/mm.

Weighs 0.25 lb (0.11 kg)

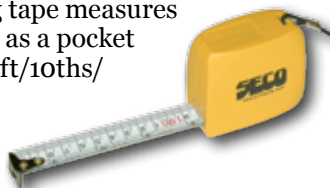

## 10-Meter RTK Radio Antenna Pole

#90036

Designed to hold a standard radio antenna at up to 10 meters, extending your RTK range.

Features non-conductive strong fiberglass tube sections for safety.

Kit contains:

- 1 ea 10 m telescopic pole
- 1 ea bottom point
- 2 ea guy rings
- 4 ea 30 ft ratcheting ropes with quick snaps
- 4 ea 40 ft ratcheting ropes with quick snaps
- 4 ea velcro straps for cable management
- 1 ea rope bag

Complete kit weighs 13 lb



## GPS Antenna Platform

#2072-40

The platform creates a very stable setup using standard cinder blocks\* as weights (sand bags may also be used).

It is ideal for network reference station installers who want to evaluate a site for multipath before committing to the installation.

The platform can be used for private network sites where the building owner does not want any permanent attachment to their building.

It can be used as a temporary site for local networks, construction sites, AG sites, etc.

The mast is 36 inches (91.44 cm) long with standard 2-inch pipe threads. Sections can be added for more height.

It comes with removable 5/8 x 11 adapter.

This platform folds up for portability and includes tools and a system carrying bag.

Platform sections hold 8 x 16-in (20.32 x 40.64 cm) cinder blocks.

Weighs (without blocks) 25 lb (11.34 kg)

\*Cinder blocks not included.



## Pole Bracket Kit for Pathfinder ProXRT

#5198-100

This pole bracket kit holds the Trimble® GPS Pathfinder® ProXRT receiver securely to any standard rover rod.

It is easy to attach and adjust the height on the rover rod. It comes with two pole clamps, one clip and two screws and the ProXRT is pre-drilled for the extra clip.

The pole clamps are made of machined anodized aluminum with stainless steel clamp screws and fit rover rods with 3/4-in (1.90 cm) to 1-1/4-in (3.17 cm) diameters.

Weighs 0.40 lb (0.18 kg)



## Radio Antenna Bracket for Tripod

#2133-05

This bracket holds a radio antenna securely to a tripod leg. The heavy-duty bracket makes plumbing the antenna easy. It fits all full-size and heavy-duty tripods and uses a 1/2-inch-long, 5/8 x 11 male stud to secure the antenna or extension.

It can be used with the SECO Six-Foot Snap Lock Radio Antenna Pole (5139-02-XXX) or any extension with a male/female 5/8 x 11 connection.

Weighs 1.55 lb (0.70 kg)



## Radio Antenna Mast Assembly

#5561-20

The SECO Antenna Mast Assembly will fit most heavy-duty-type tripods (like the SECO #5203-10) after the bolt assembly has been removed.

The mast telescopes to 7.5 ft (2.3 m) - plus your tripod height for maximum height.

It's easy to install and a hex tool is included.

Convert your extra tripod to a radio base set-up!

Weighs 2.5 lb (1.13 kg)

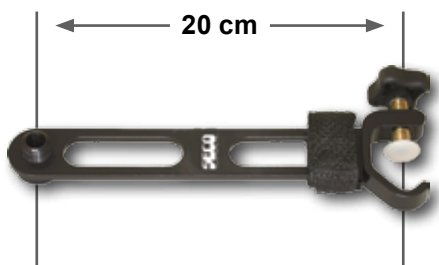

## Antenna Bracket

#2133-03

The open clamp attachment allows quick and easy connection to the pole. It connects to 1-to-1.25 inch (25.4-to-31.8 mm) OD poles. The brass male 5/8 x 11 captive stud is easily removed for direct attachment of the radio antenna to the bar. The bracket comes with a non-slip Velcro® cable strap (#8124-012) to help manage the radio cable.

Weighs 0.22 lb (0.10 kg)

It can be used with the SECO Radio Antenna Adapter (#2133-00) which adapts 1-1/8 x 18 radio antennas to any 5/8 x 11 threaded tip.



 Tech Tips available at [www.surveying.com](http://www.surveying.com)

## Antenna Mast Bracket

#2133-10

This bracket allows assembly of sections of standard diameter poles to obtain the desired height above ground of a GPS or radio antenna. It works with any standard 5/8 x 11 tripod and any pole sections 1-to-1.25 inch (25.4-to-31.8 mm) OD poles. Easy and controlled setups are achieved by lifting one section at a time up through the bracket. 6-to-7 meters height is stable when using 1.25-inch sections. For windy conditions or higher setups a plate for attaching guy wires can be used.

Weighs 0.95 lb (0.42 kg)



## Radio Antenna Tripod with Antenna Mast

#5300-11 — Hardwood/Fiberglass (shown)  
#5300-12 — Aluminum

This tripod with antenna mast gets your radio antenna to the desired height. The mast telescopes to 7.5 ft (2.3 m) and the tripod can be set to 5.5 ft (1.7 m) for a total elevation of 13 ft (4 m). The mast is aluminum with a male 5/8 x 11 tip. The tripod is the SECO #5302-10-ORG. The antenna mast (shown above) can be purchased separately to convert your own heavy-duty tripod as well (see #5561-20 above).

Weighs 19 lb (8.62 kg)

## GPS Truck Door Bracket

#5114-20-FLY

This system holds a GPS or RTK-type rod to the door of your survey truck. It's easy to set up and fits most mid- to full-size pickups and SUVs. Open and close the doors, roll the windows up and down, all normal door functions are preserved!\*

 Demo video available at [www.surveying.com](http://www.surveying.com)

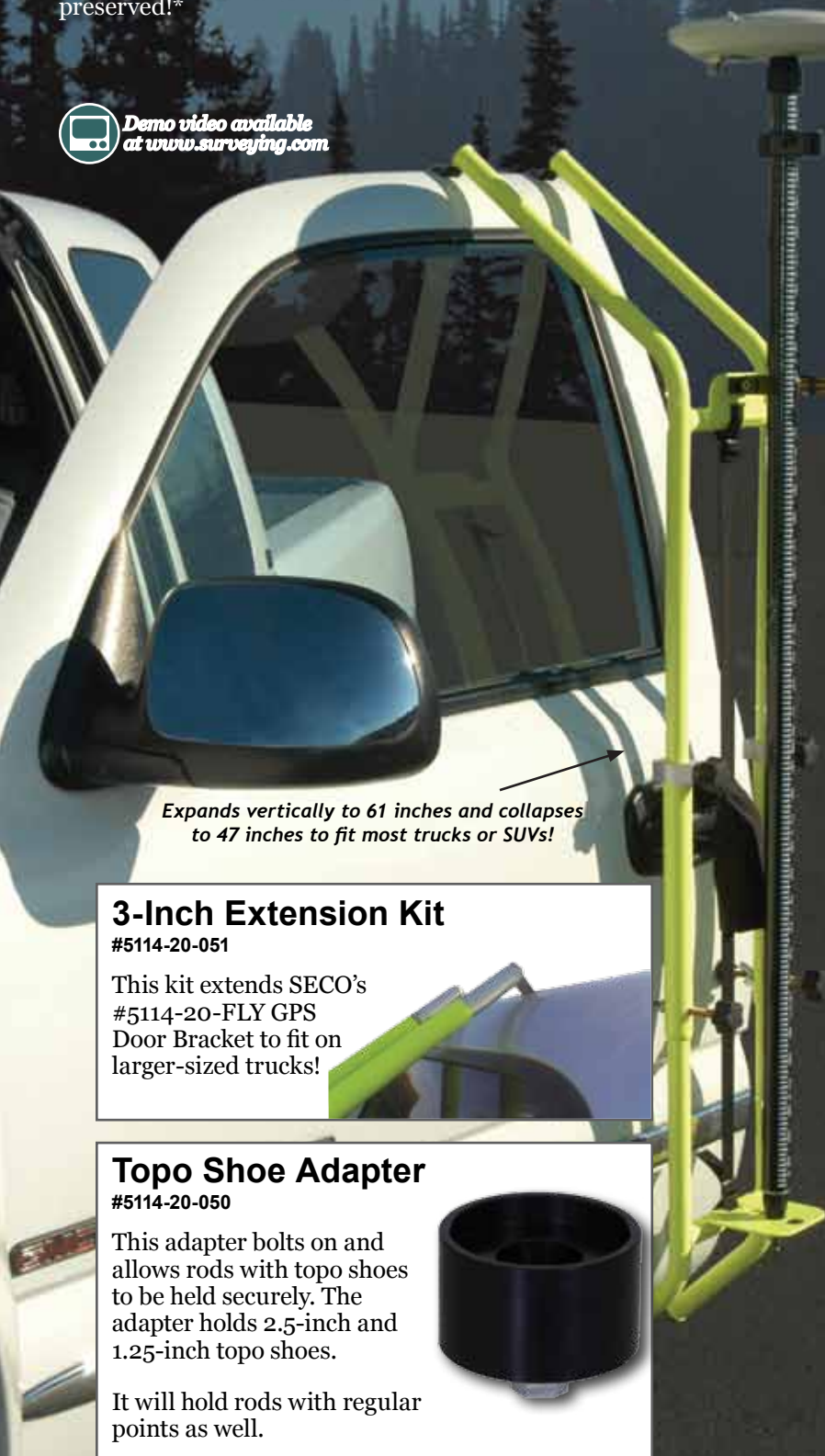

Expands vertically to 61 inches and collapses to 47 inches to fit most trucks or SUVs!

### 3-Inch Extension Kit

#5114-20-051

This kit extends SECO's #5114-20-FLY GPS Door Bracket to fit on larger-sized trucks!



### Topo Shoe Adapter

#5114-20-050

This adapter bolts on and allows rods with topo shoes to be held securely. The adapter holds 2.5-inch and 1.25-inch topo shoes.

It will hold rods with regular points as well.



## Interior Controller/Collector Bracket System

#5199-60 (shown)

This bracket series is designed to hold your collector or controller inside the cab of your survey vehicle. Use it in conjunction with the #5114-20-FLY at left and you can watch the GPS data from the comfort of the cab.

The suction cup mount will grip any clean glass or slick surface.



Includes a two-hole base mount for permanent placement!

Number:	Designed For:
5199-60 (Claw)	TSC2™, Ranger™ 300X, 500X
5199-62 (Claw)	Allegro, Allegro MX, Jett®-ce, FC-2200
5199-63 (Claw)	Recon®
5199-64 (Claw)	FC-100, Mobile Mapper CE/CX, ProMark™ 3
5199-65 (Claw)	FC-1000, FC-2000
5199-66 (Claw)	GMS-2, GMS-2 PRO
5199-67 (Claw)	Archer, Leica DX10, Carlson Mini, Javad Victor
5199-68 (Claw)	FC-200, FC-120
5199-69	GeoXT™ (use with your Trimble cradle #53500-00)
5199-70 (Claw)	Nomad® 800 Series
5199-71 (Claw)	GeoCE™, XT™, XM™, XH™, Geo 2008
5199-72 (Claw)	Workabout Pro
5199-73 (Claw)	Carlson Surveyor, Surveyor+
5199-74 (Claw)	FC-2500

\*Not intended for use at highway speeds.

# The Claw™

The Claw™ is a new and improved anodized aluminum clamping system from SECO, featuring an innovative clamping device that keeps your expensive data collecting hardware snug on the pole where it belongs without crushing it.

## Quick-Release Cradle

Number:	Designed For:
5200-050	TSC2™, Ranger™ 300X, 500X
5200-052	Allegro, Jett®•ce, Explorer, Tracker, FC-2200
5200-053	Recon®
5200-054	FC-100, Mobile Mapper CE/CX, ProMark™ 3
5200-056	GMS-2, GMS-2 PRO
5200-057	Archer, Leica DX10, Carlson Mini, Javad Victor
5200-058	FC-120, QR, FC-200
5200-059	Nomad™ 800 Series
5200-060	GeoCE™, XH™, XT™, XM™
5200-061	Workabout Pro
5200-062	Carlson Surveyor, Surveyor+
5200-063	FC-2500



## Quick-Release Clamp (for 1.25-inch OD poles)

Number:	Features:
5200-150	Plain
5200-151	With 40-min Vial
5200-152	With 20-min Vial
5200-153	With 8-min Vial
5200-154	With Compass
5200-155	With 40-min Vial and Compass (Shown)



## Ball-and-Socket Link

#5200-201

Perfect for your custom solution! It fits the 1-inch ram ball on cradles and clamps.



**ATV Ball Clamp**  
#5199-050



**Suction Cup**  
#5199-054



**Ram Ball**  
#RAM-B-238



**Tripod Mount**  
#5199-051



**1-Inch OD Pole Adapter**  
#D11145

Use this adapter if you have a 1-inch OD pole and want to use a Claw pole clamp.



## Ball-and-Socket Combo

Demo video available at [www.surveying.com](http://www.surveying.com)

Number:	Designed For:
5200-00	TSC2™, Ranger™ 300X, 500X
5200-02	Allegro, Jett®•ce, FC-2200, Explorer, Tracker
5200-03	Recon®
5200-04	FC-100, Mobile Mapper CE/CX, ProMark™ 3
5200-05	FC-1000, FC-2000
5200-06	GMS-2
5200-07	Archer, Leica DX10, Carlson Mini, Javad Victor
5200-08	FC-120, QR, FC-200
5200-09	Nomad™ 800 Series
5200-10	GeoCE™, XH™, XT™, XM™
5200-11	Workabout Pro
5200-12	Carlson Surveyor, Surveyor+
5200-13	FC-2500
5200-15	Leica Viva CS10/CS15



## Ball-and-Socket Cradle (with 1-inch ram ball)

Number:	Designed For:
5200-00-050	TSC2™, Ranger™ 300X, 500X
5200-02-050	Allegro, Jett®•ce, Explorer, Tracker, FC-2200
5200-03-050	Recon®
5200-04-050	FC-100, Mobile Mapper CE/CX, ProMark™ 3
5200-06-050	GMS-2, GMS-2 PRO
5200-07-050	Archer, Leica DX10, Carlson Mini, Javad Victor
5200-08-050	FC-120, QR, FC 200
5200-09-050	Nomad™ 800 Series
5200-10-050	GeoCE™, XH™, XT™, XM™
5200-11-050	Workabout Pro
5200-12-050	Carlson Surveyor, Surveyor+
5200-13-050	FC-2500
5200-15-050	Leica Viva CS10/CS15



## Ball-and-Socket Clamp

(with 1-inch ram ball - for 1.25-inch OD poles)

Number:	Features:
5200-160	Plain (shown)
5200-161	With 40-min Vial
5200-162	With 20-min Vial
5200-163	With 8-min Vial
5200-164	With Compass
5200-165	With 40-min Vial and Compass



## Open Clamp Pole Brackets and Cradles

SECO's original Open Clamp Pole Brackets and Cradles offer a fast and efficient way to mount data collectors or controllers to antenna poles and rover rods! Use a Claw Quick-Release cradle (previous page) or a standard cradle (listed below) and one of the popular open clamps (below) for a complete solution. Clamps and cradles are sold separately for easy customizing.

The aluminum open clamp features a quick-release button and a stainless steel clamp screw that attaches to the pole. Depressing the quick-release button will allow the Claw Quick-Release Cradle or standard cradle to rotate in to a comfortable position for reading the data collector or controller.

Brackets #5198-052, -054, -055, -056, and -059 are designed for standard poles or rods with a 0.75-to-1.25-inch OD. The #5198-152 is designed for larger 1.5-inch OD rods and poles.

All SECO pole brackets and cradles are manufactured from black anodized aluminum.

<i>Number:</i>	<i>Type:</i>
5198-052	Bracket: Plain
5198-054	Bracket: With 40-minute Vial
5198-055	Bracket: Compass
5198-056	Bracket: Compass and 40-minute Vial (shown)
5198-059	Bracket: With 0.15 x 0.92-inch Slot
5198-152	Bracket: For 1.5-inch OD Pole
5198-073	Cradle: Designed for Nautix N7, DAP 9800, SDR33, Titan
5198-081	Cradle: Designed for PDA
5198-086	Cradle: Designed for Leica RX and Viva CS10/CS15 (shown)



## ATV Pole Bracket System with Radio Antenna Bar

#5198-50

The SECO ATV Pole Bracket System is designed to hold a rover rod and a radio antenna pole (sold separately).

The universal bracket system fits most ATVs, it attaches with u-bolts to the luggage rack.

The bracket holds all poles from 1-to-1.25-inch outside diameter. Quick clamp handles make loading and unloading the rover pole fast and secure.

Installation to the ATV takes about one hour using basic tools.

This system comes with a transport and storage bag.

Weighs 24 lb (10.89 kg)

## ATV Pole Bracket System

#5198-51 (shown)

The SECO #5198-51 ATV Pole Bracket System is the same as above but does not include the radio antenna bar.



## CRAIN®

### Data-Max Data Collector Holders

Some metal data collector holders can cause irreparable damages to the pole by repeated tightening or over-tightening of the clamp to the same point on the pole. The Data-Max's patented clamping system is designed to grasp the pole or tripod securely without harm.

This is accomplished with the use of elastomeric materials, a large, uniform clamping area and a knob that is designed to help prevent over-tightening.

The patented design of the Data-Max™ allows the user to position their data collector in one of twenty-six positions for better viewing and ease of use. Whether you are using it on a pole or tripod, the connection is quick and simple. When in use on a tripod, the clamping arms may be left in the open position for easy access, and then locked in place when necessary.



### Data-Max Collector Cradles with Dash Mount

#91827 (shown)

Number:	Designed For:
91802	Topcon FC-100
91827	TDS Recon®
91828	TDS Nomad™
91842	Jett®•ce, Explorer, Tracker
91852	TDS Ranger™ 200C
91856	TDS Ranger™ 300X-500X
91861	Trimble® TSC2
91877	Allegro
91879	Otterbox 1900
91881	Otterbox 2600



### Data-Max Collector Cradles

#91960 (shown)

Number:	Designed For:
91940	Jett®•ce, Explorer, Tracker
91950	Topcon FC-100
91960	TDS Recon®
91962	TDS Nomad™
91965	TDS Ranger™ 200C
91966	TDS Ranger™ 300X-500X
91969	Trimble® TSC2
91970	Allegro
91979	Otterbox 1900
91980	Otterbox 2600



### Data-Max Collector Cradles with Pole Mount

#91825 (shown)

Number:	Designed For:
91800	Topcon FC-100
91825	TDS Recon®
91826	TDS Nomad™
91840	Jett®•ce, Explorer, Tracker
91850	TDS Ranger™ 200C
91855	TDS Ranger™ 300X-500X
91860	Trimble® TSC2
91875	Allegro
91878	Otterbox 1900
91880	Otterbox 2600



### Data-Max Pole Mount

#91900

The modular design of the Data-Max allows for multiple data collectors (and cradles) to be used with the same pole mount.



*Note: If purchasing Data-Max mounts and cradles separately, a swivel coupling (#91930) is necessary.*

# Vials and Levels

## Vials for TLV™ Locks



#5500-064-40  
(Complete with 40-min vial)



40-Minute Vial  
#D11232  
Includes screws



20-Minute Vial  
#D11233  
Includes screws



8-Minute Vial  
#D11234  
Includes screws

## Vials for QLV™ Locks



#5801-052-40  
(Complete with 40-min vial)



40-Minute Vial  
#D11243  
Includes screws



20-Minute Vial  
#D11242  
Includes screws



8-Minute Vial  
#D11241  
Includes screws

## Vials for 1.25-inch OD Pole Levels



#5081-052-40  
(Complete with 40-min vial)



40-Minute Vial  
#D11232  
Includes screws



20-Minute Vial  
#D11233  
Includes screws



8-Minute Vial  
#D11234  
Includes screws

## Vials for 1.50-inch OD Pole Levels



#5070-051-40  
(Complete with 40-min vial)



40-Minute Vial  
#D11232  
Includes screws



20-Minute Vial  
#D11233  
Includes screws



8-Minute Vial  
#D11234  
Includes screws

## The Heads-Up Level for Antenna Tripod

#5001-24 — 10-minute bubble

Here's an invaluable piece of equipment to add to your antenna tripod. The Heads-Up™ level is more comfortable to read; the bubble is direct reading. Fits 1.5-in OD pole.

Weighs 0.35 lb (0.16 kg)



## The Original Heads-Up Level

#5001-20 — 40-minute bubble  
#5001-25 — 10-minute bubble

This innovative tool gives you an added sense of safety while doing routine surveys in traffic areas. You no longer need to look down while traffic is flying by — simply look through the window. You can keep your surveying partner in sight for faster surveying, too! The Heads-Up™ level is more comfortable to read; the bubble is direct reading. Weighs 0.40 lb (0.18 kg)



Demo video available at [www.surveying.com](http://www.surveying.com)



## Heads-Up Rod Level

#5001-21

The Heads-Up™ Rod Level offers the same kind of advantages as the two above. Due to the unique prismatic design the bubble is direct reading and centered by moving exactly in the direction needed. It is suitable for use with track light, robotic instruments, or conventional leveling. Features 40-minute sensitivity.

Weighs 0.5 lb (0.22 kg)



## Pole Peg Adjusting Jig

#5195-01

Convenient for adjusting and calibrating pole vials.

The adjusting jig features an 'L-bracket' to rest the prism pole point on and the adjustable top piece.



Tech Tips available at [www.surveying.com](http://www.surveying.com)

## Standard Rod Level

#5001-10

The Standard Rod Level has a die-cast aluminum body and an adjustable 40-minute vial. It is powder-painted orange. The Rod Level fits round or rectangular rods.

Weighs 0.25 lb (0.11 kg)



## Snap-On Rod Level

#5001-12



Clips onto 1 and 1.25 inch diameter poles and both round and rectangular rods.

The 40-minute vial is top-mounted for easy use and adjustment.

Weighs 0.10 lb (0.04 kg)





## 360° Robotic Prism Assembly

#6401-00-YEL — For Topcon Users, #6401-00-RC3 — Includes Prism and RC3 Adapter

The assembly features six 35-mm prisms — copper-coated for moisture prevention. 0-offset; 77 mm prism height. Weighs 1.8 lb (0.8 kg)

## Adapter Kit for Topcon RC2 and RC3 Users

#6401-011 (RC2 not shown), #6401-00-RC3-050 (RC3 shown at right)

Lock the adapter plate into position to hold a Topcon RC2 or RC3.

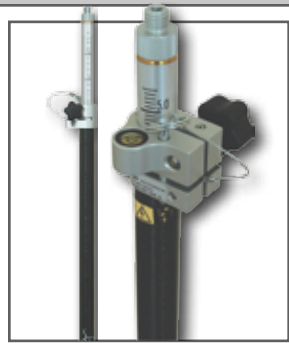

## One-Section Carbon Fiber Robotics Pole

#5129-52 — Dual Graduations

#5129-53 — Metric

These telescoping poles are graduated to read direct for a 135 mm prism height. Adapters (shown below, left) will achieve other prism heights. The carbon composite and aluminum construction make these poles 30% lighter than similar prism poles.

Features include a stainless steel pin which locks the inner pole allowing no slippage or length change of the pole. The holes are spaced every 0.5 ft on the #5129-52 and every 20 cm on the #5129-53. The popular TLV™ which has a 40-minute vial built-in to the lock is included. The inner poles have dual graduations: centimeters and 0.01 ft on the #5129-52; and centimeter graduations on the #5129-53. The poles collapse to 4.97 ft (1.516 m) and extend to 8.53 ft (2.60 m). Weighs 2.3 lb (1.04 kg).



## Two-Section Carbon Fiber Robotics Pole

#5129-72 — Dual Graduations

#5129-73 — Metric

These poles achieve 135 mm height to target. The poles are taller two-section versions of the #5129-52 and #5129-53. The poles collapse to 5.18 ft (1.58 m) and extend to 11.81 ft (3.60 m).

Weighs 3.3 lb (1.5 kg)

## Prism Height Adapters

#2090-01 — 135-0 mm (shown)

#2090-02

#2090-04

#2090-06

These 5/8 x 11 male/female aluminum adapters allow the base pole #5129-52 to work with other manufacturer's 360° prisms.



**Topcon** users w/ 77-mm 360° prism:  
order #5129-52 with #2090-01 adapter.

**Leica** users w/ 86-mm 360° prism:  
order #5129-52 with #2090-02 adapter.

Other users w/ 115 mm std. prism:  
order #5129-52 with #2090-04 adapter.

To convert robotic pole to GPS pole use  
#2090-06 adapter.

## Padded System Bags

External and internal side pockets hold a prism with pole, bipod, controller, and radio.

### Short Padded Bag

#8157-00-ORG

6-inch OD x 42 inches.  
Weighs 2.5 lb (1.14 kg)

### Long Padded Bag

#8157-01-ORG

6-inch OD x 58 inches.  
Weighs 2.7 lb (1.23 kg)

### Robotics Backpack

#8134-00-GRN

See the Padded Field Cases section,  
page 74.

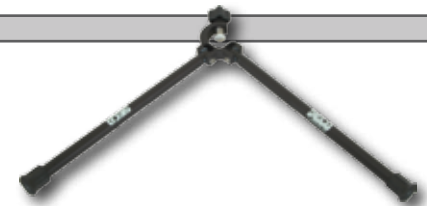

## 12-inch Bipod

#5217-15-ABK

The 12-inch, lightweight bipod is used to keep a GPS or robotic pole off the ground when not in use. Weighs 0.9 lb (0.41 kg)

## Rodrest

#5214-01 — 1.25-inch OD (shown)

#5214-02 — 1-inch OD

The Rodrest is a self-retracting 'kickstand' for survey rods.

It's activated by simply pushing down a few inches on the handle.

Weighs 1.55 lb (0.70 kg)

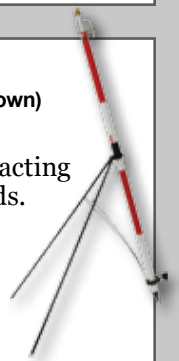

# Specialty Prism Poles

SECO specialty prism poles are designed for specific situations or hardware needs. Whether it's a preference for carbon fiber or need of a pole with a 'Swiss-style' tip, SECO has it covered!

- Sturdy aluminum, carbon fiber or fiberglass construction
- Permanent silk-screened graduations
- Brass hybrid tips and famous TLV™ or new QLV™ locking
- Aluminum poles are electrostatically powder-painted

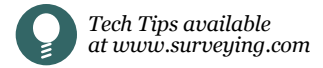

## Non-Conductive Fixed-Height Prism Pole

#90275 — 5-Foot (shown)  
#90274 — 1.3-meter

This fixed-height fiberglass prism pole measures 5-foot (1.52-meter) with your prism and adapter or 4.557-ft (1.39-meter) without prism and adapter.

Spectra/Trimble 135-mm prisms read direct (no adapter required).

Topcon 77-mm prisms require adapter #2090-01 (sold separately).

Leica 86-mm prisms require adapter #2090-02 (sold separately).

SECO/Sokkia/OMNI 115-mm prisms require part #2090-04 (sold separately).

Weights 1.1 lb (0.50 kg)



## QLV Pole for Robotics Applications

#5802-10 Dual Grads — 8 ft  
#5802-11 Metric Grads — 8 ft  
#5802-20 Dual Grads — 12 ft  
#5802-21 Metric Grads — 12 ft

This pole features the new QLV locking mechanisms. The lower lock features an adjustable 40-minute adjustable vial.

The small-diameter, 25-mm bottom section fits Leica slide-on controller brackets.

It has a Swiss-style quick release stud and reads direct for any 86-mm height prisms.

#5802-10 & #5802-11 weigh 2.50 lb (1.13 kg)

#5802-20 & #5802-21 weigh 3.55 lb (1.61 kg)



## Mini Stakeout

#5010-00-RED

Measures 1.28 ft (0.39 m), also available in flo yellow and orange. Weighs 1.50 lb (0.68 kg)

## Mini Pole

#5500-23

Features dual grads, adjustable tip and TLV lock. Extends to 5.10 ft (1.55 m), collapses to 2.70 ft (0.82 m). Weighs 2.3 lb (1.04 kg)

## Mini Rod

#5010-01

Handheld rod features height of 120 mm, 40-min vial and removable tip. Weighs 0.4 lb (0.02 kg)



## Carbon Fiber Pole

#5129-54

This pole features dual grads; an adjustable tip that will adjust to a prism height of 65 mm-to-115 mm; and TLV locking.

Extends to 8.53 ft (2.60 m), collapses to 4.97 ft (1.51 m).

This prism pole is a lighter version of the popular #5500-11 pole (see page 21).

Carbon fiber poles are approximately 30% lighter than conventional poles!

Weights 2.3 lb (1.05 kg)



## Swiss-style TLV Prism Pole

#5501-11 — Dual Grad  
#5521-11 — Metric Only

This pole features dual graduations (or metric only) for GPH1-type prisms, a Swiss-style tip (for 86 mm prism heights) and TLV locking.

It extends to 8.53 ft (2.60 m) and collapses to 4.97 ft (1.51 m).

The pole has an outside diameter of 1.25 inches (31.75 mm).

Weights 3.3 lb (1.5 kg)

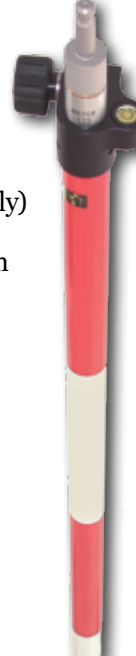

## Swiss-style Twisting Lock Prism Pole

#5503-30

This pole is graduated for GPH1-type prisms. It features a Swiss-style tip and twist locking.

It extends to 15.25 ft (4.65 m) and collapses to 5.41 ft (1.65 m).

The pole has an outside diameter of 1.50 inches (38.1 mm).

For 86 mm prism heights.

Weights 7.6 lb (3.45 kg)

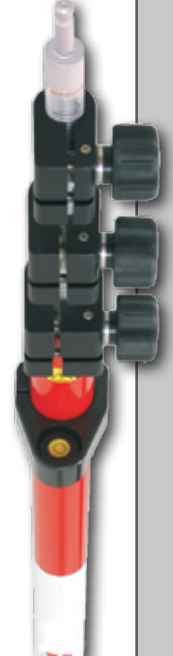

## Geodimeter Style Telescoping Prism Pole

#5120-Series

Small in diameter (20 mm) this light weight prism pole is designed to work with the Geodimeter® style sliding prism.

It is an excellent pole/prism configuration for all survey applications.

The prism can be mounted on the site rod or the graduated outer section.

The telescoping section is graduated in feet and centimeters and collapses to 4.80 ft (1.46 m) and expands to 8.60 ft (2.62 m).

The graduations in feet, 10ths and 100ths are on the outer section for direct reading of prism height.

The site rod can be used as a short hand held rod with two height marks, 0.50 ft (15.24 cm) and 1.00 ft (30.48 cm).

It comes with the QLV™ locking mechanism with a 40-min circular, adjustable vial.

This pole also comes with two OD adapters for bipods and data collector attachment.

This pole has a hardened steel removable point.

It is painted bright fluorescent orange.

Weights 2.75 lb (1.24 kg)

Prism and bipod not included.

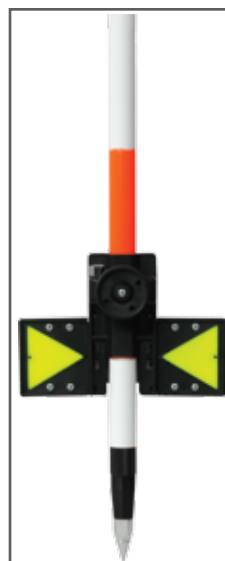
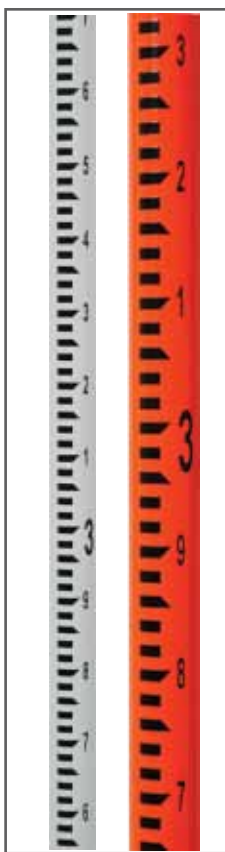

Comes with two 1.25-inch OD adapters! (#5120-030)



Number:	Description:	Weights:
5120-00-FOR-GT	Pole Only, ft	2.05 lb (0.92 kg)
5120-01-FOR-GM	Pole Only, cm	2.05 lb (0.92 kg)
5120-02-FOR-GT	Pole w/Site Rod, ft	2.75 lb (1.24 kg)
5120-03-FOR-GM	Pole w/Site Rod, cm	2.75 lb (1.24 kg)
5120-024-FOR	Site Rod w/Point, cm	0.70 lb (0.31 kg)
5120-025-FOR	Site Rod w/Point, ft	0.70 lb (0.31 kg)



Demo video available at [www.surveying.com](http://www.surveying.com)

# Telescopic Quick Change Prism Poles

This pole system is designed to be compatible with all targets, prisms, and GPS antennas. Use the appropriate adapter to achieve a target height of 150 mm.

- Quickly change applications by switching adapters
- Simple adapter determination
- SECO TLV™ locking mechanism
- Available with or without locking pin & holes

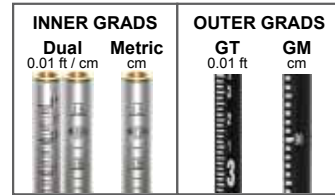

## Pole Types (#2090-12 adapter tip included)

Number:	Grads:	Graduated Length:	Outer Pole:	Locking Pin:
5507-10	Dual	4.36 to 7.22 ft	Aluminum	
5507-11	Dual	1.64 to 2.30 ft	Aluminum	
5507-13	Dual	4.36 to 7.22 ft	Carbon Fiber	Yes
5507-15	Dual	4.97 to 8.53 ft	Aluminum	
5507-16	Dual	4.97 to 8.53 ft	Carbon Fiber	
5507-17	Dual	4.97 to 8.53 ft	Carbon Fiber	Yes
5507-20	Dual	5.18 to 11.81 ft	Aluminum	
5507-22	Dual	5.18 to 11.81 ft	Carbon Fiber	Yes
5507-30	Dual	5.41 to 15.25 ft	Aluminum	
5527-10	Metric	1.33 to 2.20 m	Aluminum	
5527-11	Metric	0.50 to 0.70 m	Aluminum	
5527-13	Metric	1.33 to 2.20 m	Carbon Fiber	Yes
5527-15	Metric	1.51 to 2.60 m	Aluminum	
5527-16	Metric	1.51 to 2.60 m	Carbon Fiber	
5527-17	Metric	1.51 to 2.60 m	Carbon Fiber	Yes
5527-20	Metric	1.58 to 3.60 m	Aluminum	
5527-22	Metric	1.58 to 3.60 m	Carbon Fiber	Yes
5527-30	Metric	1.65 to 4.65 m	Aluminum	

Aluminum and carbon fiber poles can be ordered with external GT or GM graduations. Aluminum GT or GM poles are powder-painted a solid color.

## Adapter Types

Number:	Target:	Target Height:	Length "L":
2090-10	Leica GPH1	86 mm	64 mm
2090-11	Zeiss 360° Prism	100 mm	50 mm
2090-12	SECO 6400 Series	115 mm	35 mm
2090-13	Trimble® RMT	135 mm	15 mm
2090-14	Adjustable 5/8 x 11	50 mm to 135 mm	N/A
2090-15	GPS Antenna	0 mm	150 mm
2090-17	Leica Adjustable	86 mm to 125 mm	N/A
2090-19	SECO Mini Prisms	70 mm	80 mm
2090-21	Topcon 360° Prism	77 mm	73 mm
2090-22	Sokkia Polycarbonate	79 mm	71 mm
5079-066	Laser Detector Adapter	150 mm	150 mm

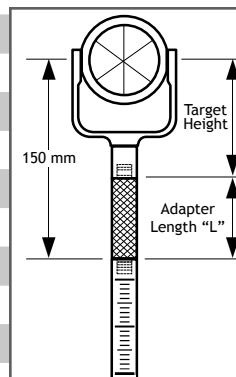

# TLV and Twist-Locking Telescopic Prism Poles

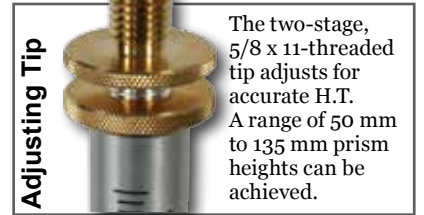
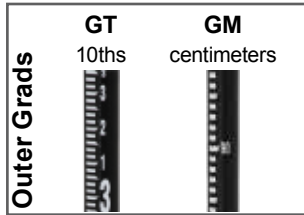
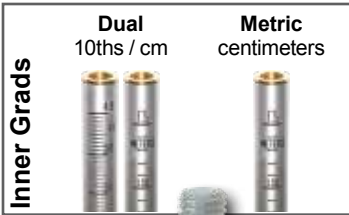

The standard SECO 5/8 x 11 top-threaded tip allows 115-mm prism heights.

The two-stage, 5/8 x 11-threaded tip adjusts for accurate H.T. A range of 50 mm to 135 mm prism heights can be achieved.



The SECO twisting lock with vial (TLV™) is wear-resistant for long life.

The soft rubber knob is easy to tighten or loosen, even when wearing gloves! TLV's feature a convenient 40-minute vial built into the lock.

Moving the vial to the lock frees up space on the pole for other accessories!

 Tech Tips available at [www.surveying.com](http://www.surveying.com)

 Demo video available at [www.surveying.com](http://www.surveying.com)

## One-Section TLV Prism Poles

Extends to 8.53 ft (2.60 m), collapses to 4.97 ft (1.516 m)  
Weighs approximately 3.3 lb (1.50 kg)

Number:	Tip:	Pole Type:	Graduations:
5500-11	Adjustable	Aluminum	Dual
5512-11	Fixed	Aluminum	Dual
5520-11	Adjustable	Aluminum	Metric

Ask about graduated outer prism pole versions!

## Two-Section TLV Prism Poles

Extends to 11.81 ft (3.60 m), collapses to 5.18 ft (1.58 m)  
Weighs approximately 5.1 lb (2.32 kg)

Number:	Tip:	Pole Type:	Graduations:
5500-21	Adjustable	Aluminum	Dual
5520-21	Adjustable	Aluminum	Metric

## Three-Section Twisting Lock Prism Poles

Extends to 15.25 ft (4.65 m), collapses to 5.41 ft (1.65 m)  
Weighs approximately 7.6 lb (3.45 kg)

Number:	Tip:	Pole Type:	Graduations:
5500-30	Adjustable	Aluminum	Dual
5520-30	Adjustable	Aluminum	Metric

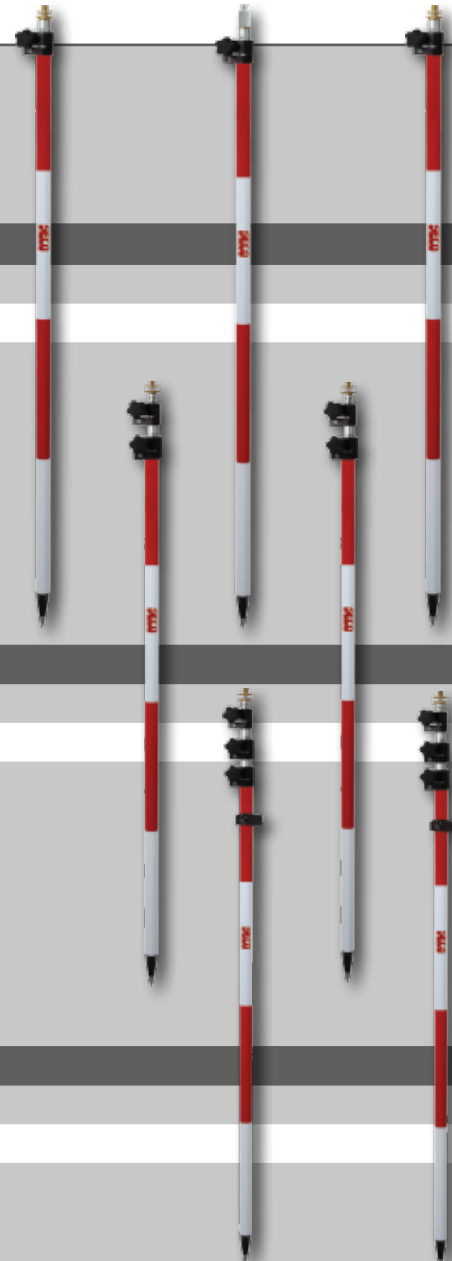

# QLV Telescopic Prism Poles



**Pole Colors:**  
Red & White,  
Flo Orange,  
Yellow



The new SECO Quick Lever with Vial (QLV™) allows fast, simple setups and easy locking.

Look how easy it is to adjust the 40-minute bubble and lever tension!

Parts lists and drawings for this and all of the SECO locking mechanisms are online at: [www.surveying.com](http://www.surveying.com).



Tech Tips available at [www.surveying.com](http://www.surveying.com)



Demo video available at [www.surveying.com](http://www.surveying.com)

## One-Section QLV Prism Poles

Extends to 8.53 ft (2.60 m), collapses to 4.97 ft (1.516 m)  
Weighs approximately 2.95 lb (1.50 kg)

Number:	Tip:	Graduations:
5801-10	Adjustable	Dual
5813-10	Fixed	Dual
5821-10	Adjustable	Metric

## Two-Section QLV Prism Poles

Extends to 12.00 ft (3.65 m), collapses to 5.30 ft (1.65 m)  
Weighs approximately 4.05 lb (1.83 kg)

Number:	Tip:	Graduations:
5801-20	Adjustable	Dual
5821-20	Adjustable	Metric
5813-20	Fixed	Dual

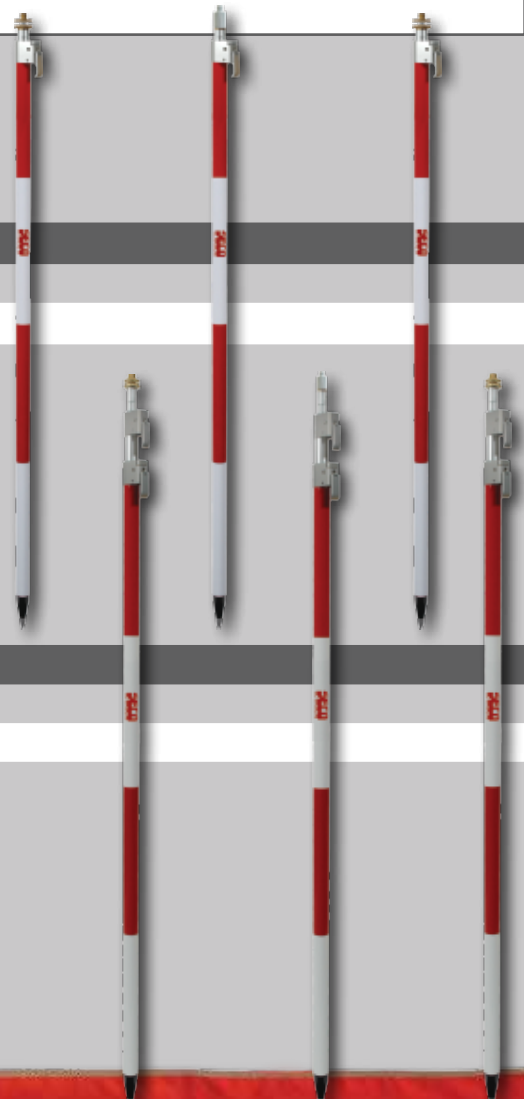

 Demo video available at [www.surveying.com](http://www.surveying.com)

## Universal Pole Bag

#8160-00-ORG



Protect your prism pole from dirt and moisture. This bag holds all poles and measures 61.5 x 6 inches (156.21 x 15.24 cm).

# Quick-Release Telescopic Prism Poles

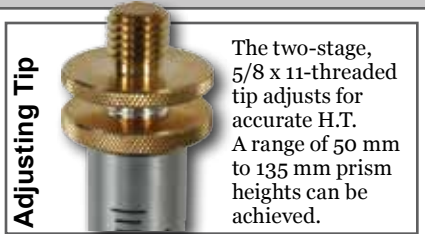
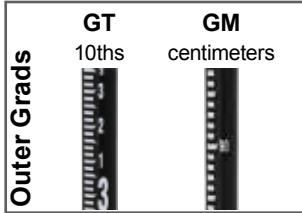

The SECO Quick-Release handle lock allows for a simple and fast setup.

This locking mechanism features adjustable tension via a set screw in the handle and another set screw to assist in keeping the spring in position. Lock includes 40-minute level vial.

 *Tech Tips available at [www.surveying.com](http://www.surveying.com)*

 *Demo video available at [www.surveying.com](http://www.surveying.com)*

## Prism Pole Hard Shell Case

8160-20-BLK

This case is a heavy-duty, polyester-covered tube that protects poles from damage. With a four-inch diameter, it holds one- or two-section poles. It's 65 inches (1.63 m) long.

Weighs 5.5 lb (2.5 kg)



## One-Section Quick-Release Prism Poles

Extends to 8.53 ft (2.60 m), collapses to 4.97 ft (1.516 m)

Weighs approximately 3.3 lb (1.50 kg)

Number:	Tip:	Graduations:
5700-10	Adjustable	Dual
5712-10	Fixed	Dual
5720-10	Adjustable	Metric
5722-10	Fixed	Metric

## Two-Section Quick-Release Prism Poles

Extends to 11.81 ft (3.60 m), collapses to 5.18 ft (1.58 m)

Weighs approximately 5.1 lb (2.3 kg)

Number:	Tip:	Graduations:
5700-20	Adjustable	Dual
5712-20	Fixed	Dual
5720-20	Adjustable	Metric

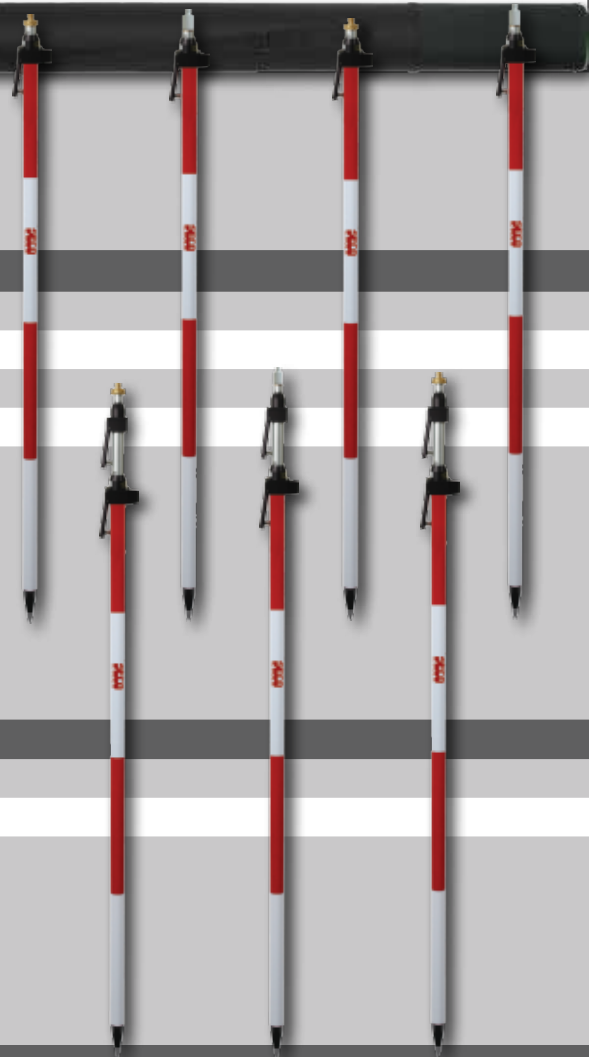

# Compression Lock Telescopic Prism Poles



**Pole Colors:**  
Red & White  
Flo Orange



**ALL METAL  
LOCKING  
MECHANISMS**



The SECO Compression Lock system provides a positive hold and years of error-free operation. The Compression Lock is constructed of brass and aluminum!

Parts lists and drawings for this and all of the SECO locking mechanisms are online at: [www.surveying.com](http://www.surveying.com).



Tech Tips available at [www.surveying.com](http://www.surveying.com)



Demo video available at [www.surveying.com](http://www.surveying.com)

## One-Section Compression Lock Prism Poles

Extends to 8.53 ft (2.60 m), collapses to 4.97 ft (1.516 m)  
Weighs approximately 3.3 lb (1.50 kg)

Number:	Tip:	Graduations:
5600-10	Adjustable	Dual
5612-10	Fixed	Dual
5620-10	Adjustable	Metric
5622-10	Fixed	Metric

## Two-Section Compression Lock Prism Poles

Extends to 11.81 ft (3.60 m), collapses to 5.18 ft (1.58 m)  
Weighs approximately 5.1 lb (2.3 kg)

Number:	Tip:	Graduations:
5600-20	Adjustable	Dual
5612-20	Fixed	Dual
5620-20	Adjustable	Metric
5622-20	Fixed	Metric

## Three-Section Compression Lock Prism Poles

Extends to 15.25 ft (4.65 m), collapses to 5.18 ft (1.65 m)  
Weighs approximately 7.6 lb (3.45 kg)

Number:	Tip:	Graduations:
5600-30	Adjustable	Dual
5620-30	Adjustable	Metric

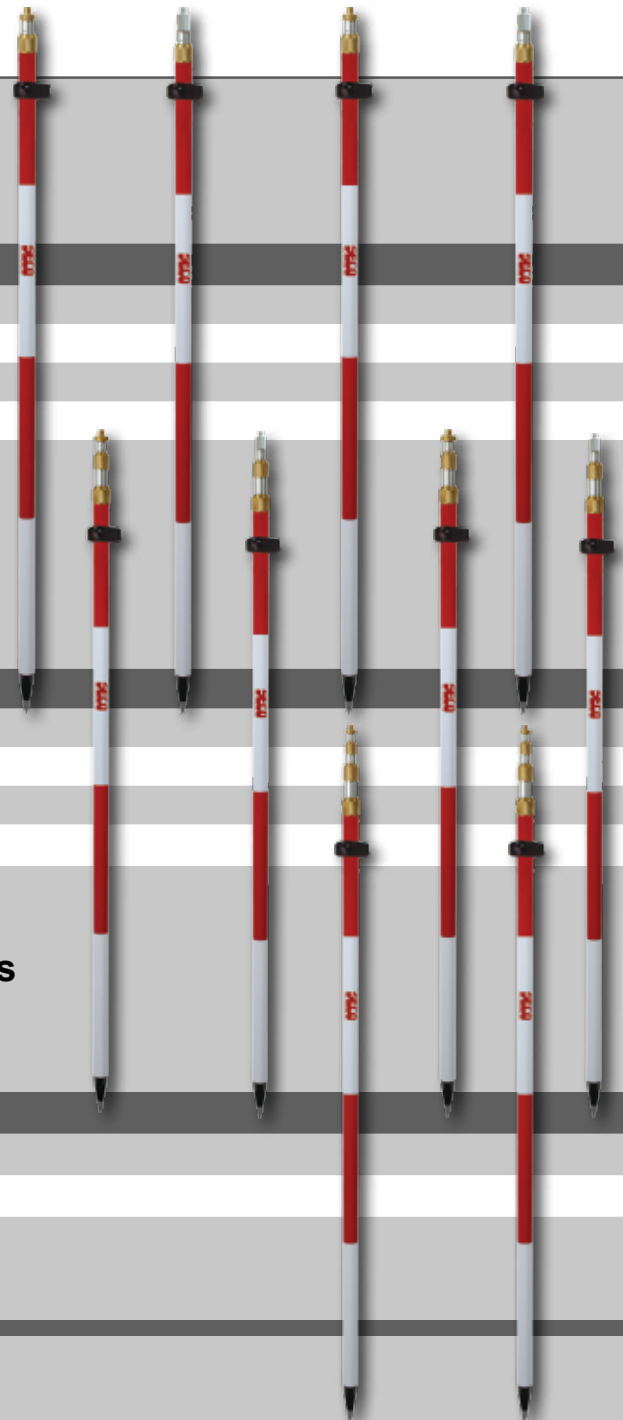



## Fiberglass Ultralite Prism Poles with TLV Locking Mechanism

SECO and Crain have combined technologies to introduce the Ultralite™, the lightest, most user-friendly, pole on the market. The inner and outer poles are constructed of lightweight non-conductive fiberglass.

Newly redesigned TLV™ (Twistlock with vial) reduces weight while providing the same locking function users have grown to expect from SECO.

Included in this package is Crain's patented Topo Boot.®

Features include a 40-minute adjustable vial, a soft touch knob, and adjustable 5/8 x 11 tip.

Also available in Flo orange and yellow.

*New Ultralite poles include removable point and topo shoe!*



Number:	Grads:	Height:	Weighs:
5540-10	Dual	8.58 ft (2.62 m)	1.95 lb (0.88 kg)
5541-10	Metric	8.58 ft (2.62 m)	1.95 lb (0.88 kg)
5540-20	Dual	11.81 ft (3.6 m)	2.5 lb (1.13 kg)
5541-20	Metric	11.81 ft (3.6 m)	2.5 lb (1.13 kg)
5540-30	Dual	15.27 ft (4.65 m)	3.15 lb (1.43 kg)
5541-30	Metric	15.27 ft (4.65 m)	3.15 lb (1.43 kg)

*Lightweight fiberglass inner and outer pole*

*Dual or metric graduated inner pole*

*TLV locking*



# Crain Telescopic Prism Poles



## **CRAIN®**

The Grip-Tite® locking system on all Crain prism poles, eliminates elevation errors due to malfunctioning locks. High-strength elastomeric pads grip the telescopic sections and can be adjusted with an allen wrench (included). Crain prism poles come with a Topo-Boot® (see page 29 for more details) and have a standard prism offset of 0.500 ft (152.5 mm). The grads are in 0.01 ft and cm. The adjustable 5/8 x 11 adapter may be preset within a 0.27-ft (82.55-mm) range to accommodate a broad range of prism heights.

### **Crain Carbonlite® (Carbon Fiber) Prism Poles**

Prism poles come with a 42-minute level vial  
(also available with 10-minute vial and Swiss-style adapter)

<i>Number:</i>	<i>Height:</i>	<i>Weight:</i>	<i>Grads:</i>
90281	8.52 ft (2.6 m)	1.90 lb (0.87 kg)	Dual
90666	2.6 m	1.90 lb (0.87 kg)	Metric
90283	11.5 ft (3.5 m)	2.25 lb (1.02 kg)	Dual
90667	3.5 m	2.25 lb (1.02 kg)	Metric
90202	15.27 ft (4.7 m)	2.90 lb (1.32 kg)	Dual
90668	4.7 m	2.90 lb (1.32 kg)	Metric

### **Crain Alumilite® (Aluminum) Prism Poles**

Prism poles come with a 42-minute level vial  
(also available with 10-minute vial and Swiss-style adapter)

<i>Number:</i>	<i>Height:</i>	<i>Weight:</i>	<i>Grads:</i>
90276	8.52 ft (2.6 m)	2.35 lb (1.07 kg)	Dual
90676	2.6 m	2.35 lb (1.07 kg)	Metric
90287	11.5 ft (3.5 m)	3.05 lb (1.38 kg)	Dual
90677	3.5 m	3.05 lb (1.38 kg)	Metric
90201	15.27 ft (4.7 m)	3.75 lb (1.70 kg)	Dual
90678	4.7 m	3.75 lb (1.70 kg)	Metric

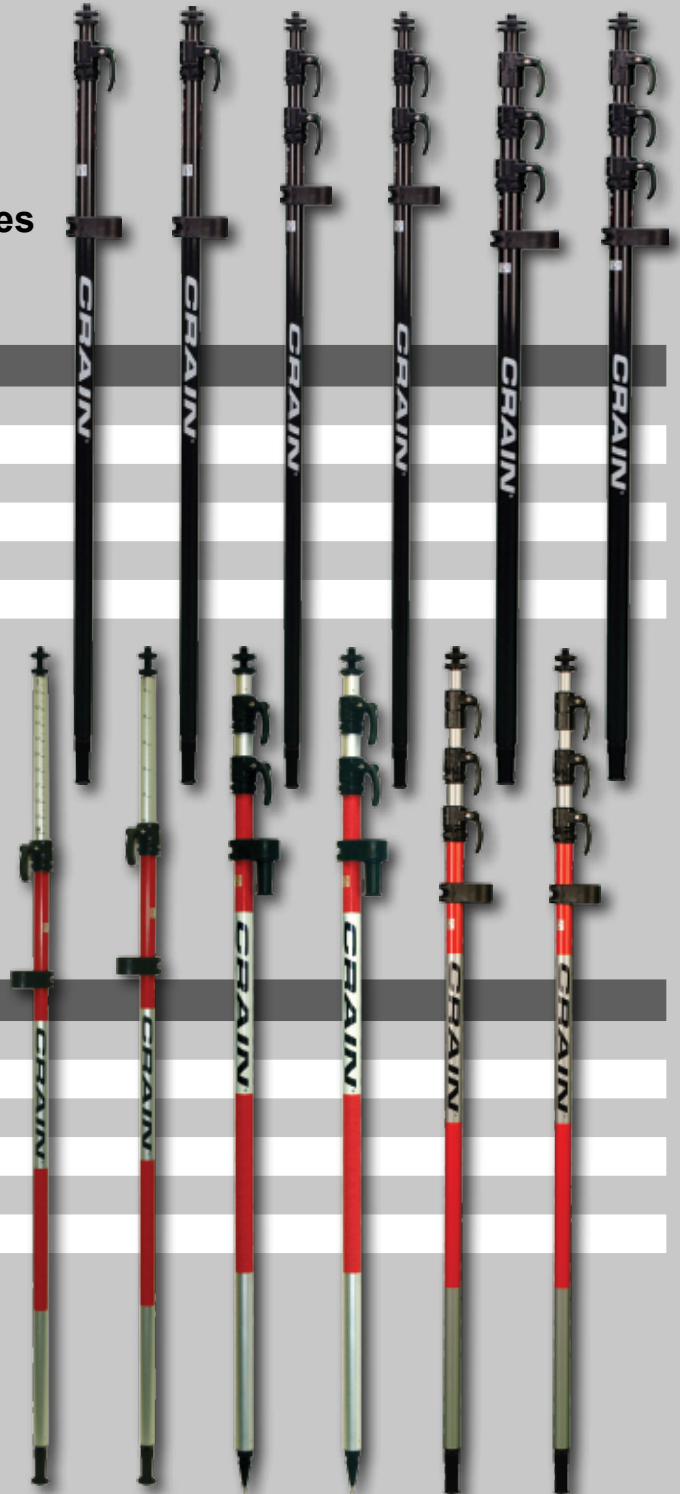



Introducing the Basics Plus line of prism poles from SECO. These ‘no-frills’ quality poles are designed to give you tremendous value at a lower cost. They feature 40-minute level vials, adjustable tips, hardened steel points, your choice of TLV-style or compression locking, and standard red and white paint.

## TLV and Twist-Locking Prism Poles

Number:	Length:	Graduations:	Weighs:
5530-10	8.6 ft	Dual	2.67 lb (1.21 kg)
5531-10	2.6 m	Metric	2.67 lb (1.21 kg)
5530-20	12 ft	Dual	3.65 lb (1.66 kg)
5531-20	3.6 m	Metric	3.65 lb (1.66 kg)
5530-30	15 ft	Dual	5.38 lb (2.44 kg)
5531-30	4.6 m	Metric	5.38 lb (2.44 kg)

## Compression-Locking Prism Poles

Number:	Length:	Graduations:	Weighs:
5630-10	8.6 ft	Dual	2.65 lb (1.20 kg)
5631-10	2.6 m	Metric	2.65 lb (1.20 kg)
5630-20	12 ft	Dual	3.45 lb (1.56 kg)
5631-20	3.6 m	Metric	3.45 lb (1.56 kg)
5630-30	15 ft	Dual	5 lb (2.27 kg)
5631-30	4.6 m	Metric	5 lb (2.27 kg)

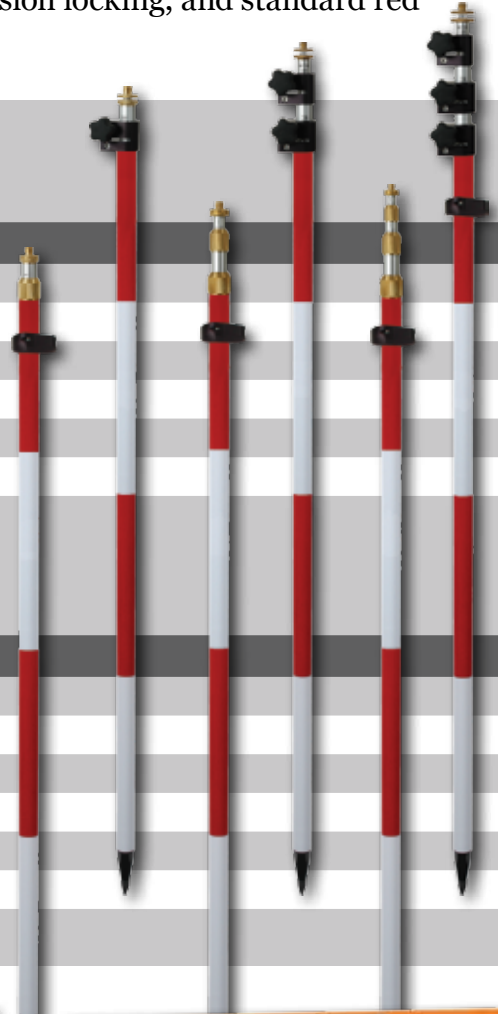

## Basics Plus Surveyors Kits

- #5280-01 — With Dual Grad Prism Pole
- #5280-02 — With Metric Grad Prism Pole

SECO's Basics Plus Surveyors Kits come with one 62 mm prism assembly (#6402-10-FOB, page 37), one dual-grad prism pole (#5530-10 or #5531-10, above), and one thumb release bipod (#5217-40-RED, page 30), making this package a great introductory kit.

Choose a kit with a graduated prism pole of your choice.

With one of these kits, all you need is your total station and tripod and you're ready to go to work.



# Prism Pole Accessories

## Wild Prism Adapter #2080-00

Adapts Swiss-style snap-on prisms to 5/8 x 11 tribrach adapter or prism pole. Weighs 0.06 lb (0.03 kg)



## Wild Prism Pole Adapter #2090-00

Adapts Swiss-style prism poles to 5/8 x 11. Weighs 0.06 lb (0.03 kg)



## Double Male Adapter #5180-00

5/8 x 11 adapter. Weighs 0.06 lb (0.03 kg)



## Prism Pole Point with Replaceable Plumb Bob Point #5194-00

3.37-inch steel body, removable point. Weighs 0.3 lb (0.14 kg)



## Prism Pole Point #5190-00

3.37-inch steel body, steel body. Weighs 0.3 lb (0.14 kg)



## Lightweight Prism Pole Point w/Replaceable Tip #5194-03 (Dull) #5194-05 (Sharp)

3.37-inch anodized aluminum body, steel point. Weighs 0.16 lb (0.07 kg)



## Titanium Prism Pole Point #5194-06

3.37-inch titanium point. Weighs 0.16 lb (0.07 kg)



## Aluminum Prism Pole Point and Steel Tip #91605

3.37-inch alum. w/ steel tip. Weighs 0.01 lb (0.004 kg)



## Wide Base Topo Shoe #5192-00

3.37-inch length, 2.5-inch (64-mm) OD., steel body. Weighs 1.26 lb (0.57 kg)



## Prism Pole Topo Shoe #5191-00

3.37-inch aluminum body. Weighs 0.34 lb (0.15 kg)



## Laser Detector Mount #91640

Converts any 5/8 x 11 prism pole to a laser rod for use with a laser at heights of 5-ft to 15-ft.

Weighs 0.60 lb (0.27 kg)



## Stedi-Rest #91641

Crain's Stedi-Rest® fits any 1.25-to-1.5-inch (32-to-38.1-mm) pole and can take the place of three separate products.

Weighs 0.15 lb (0.07 kg)



## Center Punch Point #5194-10

The #5194-10 fits all poles or products with male 5/8 x 11 threads.

The hardened steel point will mark all metal and non-metal surfaces.

Weighs 0.2 lb (0.09 kg)



## Adjustable Offset Bar #5198-163

This adjustable offset bar can be used with total stations and prism poles to help get accurate elevation measurements in hard-to-reach places.

It can be used with any standard survey pole; simply unscrew the pole point, attach it to the brass male 5/8 x 11, then attach the pole to the female 5/8 x 11.

It has an adjustable centerline, 1.60-to-1.00-ft (48.76-to-30.48-cm) in 0.20-ft (6.09-cm) increments. The offset bar is ideal to measure sewer inverts down manholes or odd surfaces on bridges and construction sites.

It is constructed of anodized 1/2-inch thick aluminum. Features include: brass male 5/8 x 11 threaded post and a stainless steel 5/8 x 11 Heli-Coil®. Weighs 1.15 lb (0.52 kg)

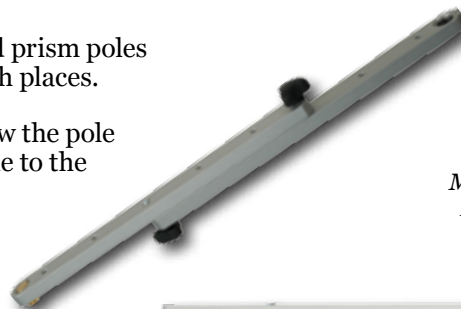

Maintains Exact Pole Elevation Readings!

Attach your prism pole and point and adjust up to 1.6 feet in width between center of the pole and prism pole point

## Offset Pole Holder Kit #5198-157

Perform odd setups and stay away from dangerous situations with the Offset Pole Holder Kit. Combine the kit with any 5/8 x 11 threaded pole and a Heads-Up™ Level for a safe and sturdy setup.

A padded case, hex wrench, and an adapter plate for instrument tripods is included!



## Pole Extensions

The pole extensions have 5/8 x 11 female threads on the bottom and 5/8 x 11 male threads on the top to allow more added sections. The aluminum extensions are powder-painted for maximum durability.

### Aluminum

#### 1-inch (25-mm) OD:

**#5182-001**

3-in (7.62-cm) Pole  
Weighs 0.4 lb (0.18 kg)

**#5132-00-ACL**

6-in (15.2-cm) Pole  
Weighs 0.5 lb (0.23 kg)

**#5130-01-FLY**

1-ft (305-mm) Pole  
Weighs 1.0 lb (0.45 kg)

**#5131-01-FLY**

2 ft (61-cm) Pole  
Weighs 1.1 lb (0.50 kg)

**#5110-01-FLY**

4-ft (1.22-m) Pole  
Weighs 1.3 lb (0.59 kg)

**#5902-00-FLY**

50-cm Pole  
Weighs 0.7 lb (0.32 kg)

**#5901-00-FLY**

1-m Pole  
Weighs 1.1 lb (0.50 kg)

#### 1.25-inch (32-mm) OD:

**#5130-00-FLY**

1-ft (305-mm) Pole  
Weighs 1.0 lb (0.45 kg)

**#5131-00-FLY**

2-ft (61-cm) Pole  
Weighs 1.1 lb (0.50 kg)

**#5110-00-FLY**

4-ft (1.22-m) Pole  
Weighs 1.3 lb (0.59 kg)

**#5145-00-FLY**

25-cm Pole  
Weighs 0.9 lb (0.41 kg)

**#5144-00-FLY**

50-cm Pole  
Weighs 1.0 lb (0.45 kg)

**#5143-00-FLY**

1-m Pole  
Weighs 1.3 lb (0.59 kg)



### Carbon Fiber

#### 1-inch (25-mm) OD:

**#5143-03**

1-m Carbon Fiber Pole  
Weighs 0.7 lb (0.32 kg)

**#5144-03**

50-cm Carbon Fiber Pole  
Weighs 0.50 lb (0.23 kg)

**#5145-03**

25-cm Carbon Fiber Pole  
Weighs 0.35 lb (0.16 kg)

**#5145-04**

0.2-m Carbon Fiber Pole  
Weighs 0.30 lb (0.14 kg)

#### 1.25-inch (32-mm) OD:

**#5143-02**

1-m Carbon Fiber Pole  
Weighs 0.7 lb (0.32 kg)

**#5144-02**

50-cm Carbon Fiber Pole  
Weighs 0.50 lb (0.23 kg)

**#5145-02**

25-cm Carbon Fiber Pole  
Weighs 0.35 lb (0.16 kg)

**#5143-10**

1.226-m Carbon Fiber Pole for Z-Max®  
Weighs 1.05 lb (0.48 kg)



### Fiberglass

#### 1.25-in (32-mm) OD:

**#5130-10**

0.200-m Fiberglass Pole  
Weighs 0.34 lb (0.15 kg)



## 10 Minute Level Vial Conversion Kit

#91628

Converts Crain prism pole standard 42-minute level vial to 10-minute for increased accuracy. Includes the 10-minute vial, aluminum sleeve and plastic insert.



## Topo-Boot

#91601

Exclusive on Crain's poles, the Topo-Boot® screws over the precision point and increases the area of the point for the use on soft surfaces in topo shots. The Topo-Boot is removable and stores conveniently under the large, easy-to-read vial. Weighs 0.05 lb (0.02 kg)



## Topo Shoe & Point Combo

#5192-02

This aluminum combo allows easy conversions from "control" to "topo" surveys. The quick-release pin and matched drill hole are the key!

Point weighs 0.15 lb (0.07 kg)  
Topo shoe weighs 0.20 lb (0.09 kg)



 Demo video available at [www.surveying.com](http://www.surveying.com)

## Heavy-Duty Range Poles

These are 1.13-inch (29-mm) OD poles, electrostatically powder coated white and orange.

### 12-ft (3.7-m) Pole - #5150-00-WOR (shown below)

Three 4-ft (1.2-m) sections, with point. Weighs 5 lb (2.27 kg)

### 8-ft (2.4-m) Pole - #5140-00-WOR

Two 4-ft (1.2-m) sections, with point. Weighs 3.4 lb (1.54 kg)

### 4-ft (1.2-m) Pole Section - #5160-00-WOR

One 4-ft (1.2-m) section, no point. Weighs 1.5 lb (0.68 kg)



## Basics Plus Range Poles

**#5160-02-WOR** — 4-Foot (1.21 m)

**#5140-02-WOR** — 8-Foot (2.43 m) — Includes bag #8170-00-ORG

**#5150-02-WOR** — 12-Foot (3.65 m) — Includes bag #8170-00-ORG

Each Basics Plus Range Pole is constructed of 1.125-inch aluminum tubing and features black anodized 5/8 x 11 male and female aluminum fittings. Poles feature an alternating orange and white pattern in 1-foot increments.



## Pole Bag

#8170-00-ORG

Heavy-Duty textured poly. Measures 46 x 7.5 inches.



**NEW!**



# Prism Pole Bipods and Tripods

SECO Bipods and Tripods are constructed of high-quality components and are designed for years of worry free service - the workmanship of every one guaranteed! Thumb Release Bipods and Tripods come in two different lightweight versions: The aluminum version features powder-coated legs and is available in four distinct colors; the other popular version features strong carbon fiber legs. SECO bipods are designed to be light but extremely strong and durable.



Tech Tips available at [www.surveying.com](http://www.surveying.com)

## The Original Thumb Release Bipod

#5217-04-YEL — SECO (shown)  
#5217-40-XXX — Basics Plus

A surveyor can set up a free-standing GPS antenna pole or prism pole. 1-to-1.25-inch (25.4-to-31.8-mm) OD poles attach easily through the open clamp. 1.5-inch (3.81 cm) OD poles can be loaded through the top.

The legs (independently) extend to 6 feet (1.8 m) and collapse to 43 inches (109 cm).

Available colors: red, yellow, flo yellow, and flo orange.

Weighs 4.25 lb (1.93 kg)

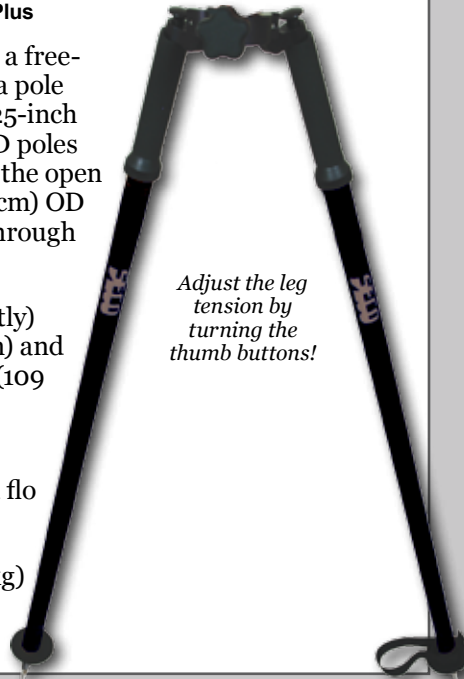

*Adjust the leg tension by turning the thumb buttons!*

## Thumb Release Mini Bipod

#5217-05-FOR

The SECO Mini Bipod utilizes the same design concepts as our popular #5217-04 bipod, it's just shorter.

1-to-1.25-inch (25.4-to-31.8-mm) diameter poles attach easily through the open clamp. 1.5-inch (3.81 cm) OD poles can be loaded through the top.

It collapses to 25 inches (63.5 cm) and extends to 35 inches (88.9 cm). The #5217-30 leg clip is included (shown below left).

Available colors: red, yellow, flo yellow, and flo orange.

Weighs 3.5 lb (1.6 kg)

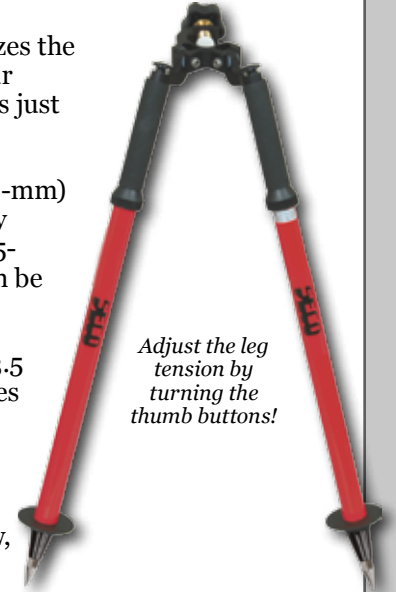

*Adjust the leg tension by turning the thumb buttons!*

## Carbon Fiber Thumb Release Bipod

#5219-03

The SECO Carbon Fiber Thumb Release Bipod uses the same design concepts as the popular aluminum Thumb Release Bipod (above), but weighs less.

1-to-1.25-inch (25.4-to-31.8 mm) diameter poles attach easily through the open clamp. 1.5-inch (3.81 cm) OD poles can be loaded through the top.

The legs (independently) extend to 6 feet (1.8 m) and collapse to 43 inches (109 cm).

Weighs 4.1 lb (1.86 kg)

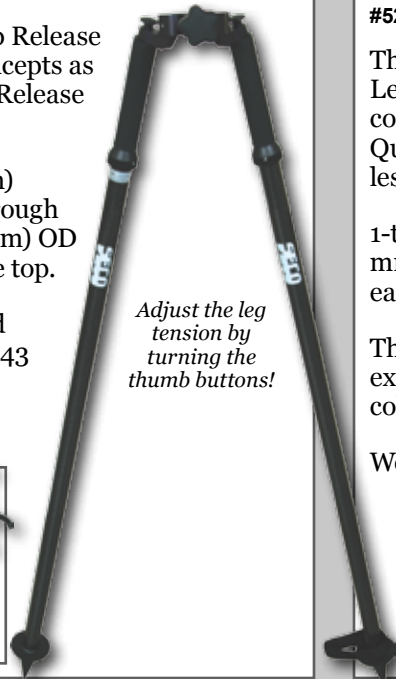

*Adjust the leg tension by turning the thumb buttons!*

## Carbon Fiber Quick Lever Bipod

#5219-50 — For 1.25-inch OD Poles (shown)  
#5219-51 — 1-inch OD Poles

The SECO Carbon Fiber Quick Lever Bipod uses the same design concepts as the popular aluminum Quick Lever Bipod, but weighs less.

1-to-1.25-inch (25.4-to-31.8-mm) diameter poles attach easily through the open clamp.

The legs (independently) extend to 6 ft (1.8 m) and collapse to 43 in (109 cm).

Weighs 4.1 lb (1.86 kg)



*Adjust the leg tension by turning the thumb buttons!*

### Add a Bipod Leg Clip #5217-30

The bipod leg clip easily attaches to the base of any 1.25-inch OD prism or antenna pole.

Weighs 0.04 lb (0.02 kg)



**Protect your bipod with a SECO bipod bag. See page 33.**



## Gardner Engineering Rodrest

#5214-01 — 1.25-inch OD (shown)  
#5214-02 — 1-inch OD

SECO now makes Gardner Engineering's Rodrest (U.S. Patent pending).

The Rodrest is a self-retracting 'kickstand' for survey rods.

It attaches quickly with one thumbscrew and is activated by simply pushing down a few inches on the handle.

The legs self-retract when the rod is lifted.

The Rodrest is made of anodized durable-machined aluminum that won't rust or fatigue and has a stainless steel clamp screw.

It holds the rod at a 20-degree zenith angle.

Weighs 1.55 lb (0.70 kg)

Pole not included.

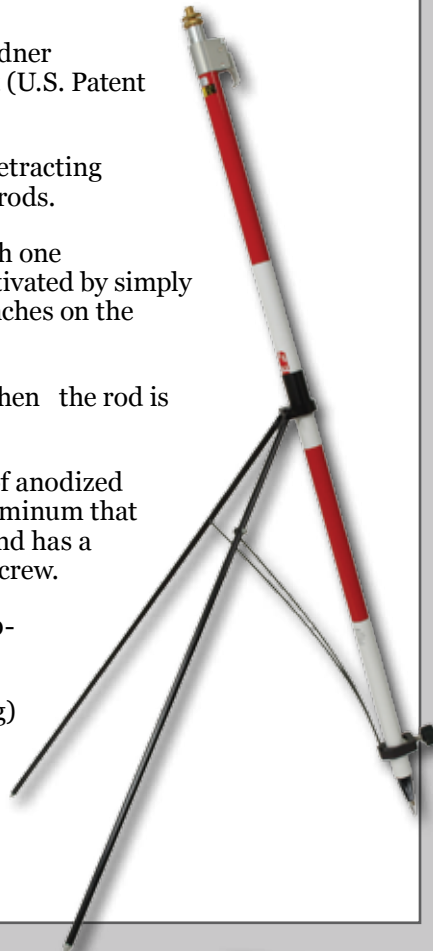

## Quick Lever Head Bipod

#5217-50-FOR — Thumb-Release Legs for 1.25-inch OD Poles  
#5217-51-FOR — Thumb-Release Legs for 1-inch OD Poles

This open-clamp head bipod features a Quick Lever™ locking mechanism that makes attaching or detaching the pole\* lightning fast — the lever cam action is mechanically simple and holds tight.

The locking mechanism is made of non-marring Delrin® with an EPDM 80-durometer rubber plug for positive grip. It works with 1 (25-mm) or 1.25-inch (32-mm) OD poles.

Weighs 4.2 lb (1.90 kg)

\*Pole not included.



## Alligator Clamp Tripod

#5214-00

The tripod features a ball-and-socket head, which makes leveling a bubble easy. The rubberized jaws hold a pole (up to 2-inch OD) firmly in place.

Telescopic legs extend from 80 cm (2.62 ft) to 127 cm (4.17 ft).

Weighs 2.65 lb (1.2 kg)



Alligator clamp with rubberized jaws!

Demo video available at [www.surveying.com](http://www.surveying.com)

## Mini-Prism Monopod Kit

#5216-00

The Mini Prism Monopod Kit forms a stable base with your SECO 6000-Series Mini Prism (sold separately).

The kit is easy to set up and can be used by just one person. It's ideal for: construction surveys, inspections, asbuilts, and many other applications.

Add a standard 5/8 x 11 extension to the kit to achieve heights to four feet.

Weighs 2.25 lb (1.02 kg)

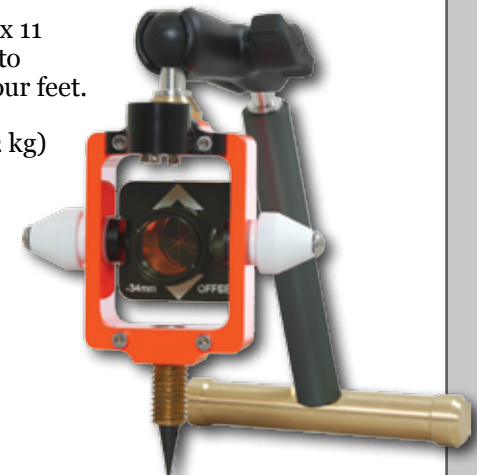

# Prism Pole Bipods and Tripods

## Dual Hinge Bipod

#5217-57 — Standard Twist-Lock  
Open Clamp

#5217-58 — Quick Lever lock for the  
1.25-inch OD pole

#5217-59 — Quick Lever lock for the  
1-inch OD pole

This bipod is perfect for setups on difficult terrain. The dual leg hinges move in two directions.

This bipod sets up fast on rocky, steep slopes, construction sites, or industrial sites where surrounding material may be in the way of proper leg placement.

The push button thumb release legs on the Dual Hinge Bipod are the same as SECO's original open clamp tripod.

The legs collapse to 43 inches (109.22 cm) and extend to 72 inches (182.88 cm).

The Dual Hinge Bipod attaches to the pole with two options: the original standard open clamp or the Quick Lever lock.

Also available in Flo Orange and Yellow

Weighs 4.2 lb (1.90 kg)

Pole not included.



*The dual leg hinges move in two directions for stable set-ups in rough terrain*





## Thumb-Release Tripod

#5218-02-YEL — SECO  
#5218-40-FLY — Basics Plus

The Thumb-Release Tripod uses the same thumb action release and lock mechanism as the Thumb-Release Bipod on page 30.

1-to-1.50-inch (25.4-to-38.1-mm) OD poles thread easily through the open clamp on top.

The legs (independently) extend to 6 ft (1.8 m) and collapse to 43 in (109 cm).

Available colors: red, yellow, fluorescent yellow, and fluorescent orange.

Weighs 6 lb (2.60 kg)

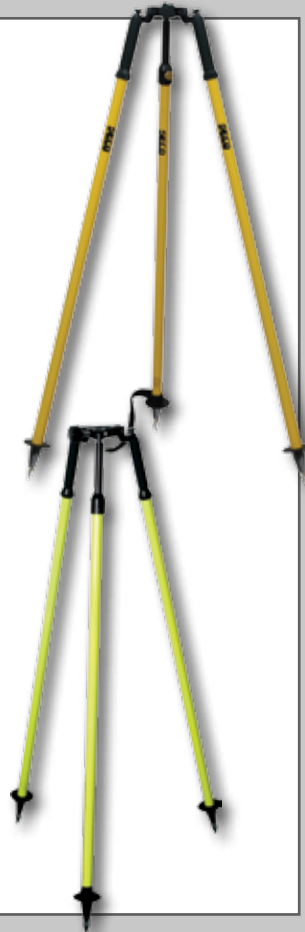

*Adjust the leg tension by turning the thumb buttons!*

## Carbon Fiber Thumb Release Tripod

#5219-05

The SECO Carbon Fiber Thumb Release Tripod uses the same design concepts as the popular aluminum Thumb Release Tripod (left), but weighs less.

1-to-1.50-inch (25.4-to-38.1-mm) OD poles thread easily through the open clamp on top.

The legs (independently) extend to 6 ft (1.8 m) and collapse to 43 in (109 cm).

Weighs 4.1 lb (1.86 kg)



*Adjust the leg tension by turning the thumb buttons!*

## Prism Pole Bipod/Tripod Bags

#8180-00-ORG — Standard Bag  
#8180-20-ORG — Rhinotek Reinforced Bottom

The prism pole tripod bags hold a prism pole with a tripod or bipod attached.

The 60-inch (152-cm) long bag has a fold-over flap and is made from sturdy nylon Cordura®.

The 8180-20-ORG features Rhinotek™ material!

Weighs 1.08 lb (0.49 kg)



## Simple Tripod with 12-Inch Legs

#5218-15-ABK

This tripod is ideal for use with poles under 24 inches long, and it's simple and easy to use!

1-to-1.50-inch (25.4-to-38.1-mm) diameter poles thread easily through the open clamp on top.

The legs are a fixed length of 12 inches each.

Other features include stainless steel clamp screw and rubber tips for gripping hard or slick surfaces.

Weighs 1.3 lb (0.6 kg)





## PRISM *Basics*

### Prism Offsets

Corner cube prisms (or retroreflectors) used with electronic distance measuring (EDM) instruments have an offset due to the fact that the transmitted light beam from the EDM takes longer to enter and exit the prism. This longer time translates to a longer distance measured. This distance is corrected by using an 'offset' and/or positioning the prism in relationship to the plumb line of the prism holder. The offset is determined by multiplying the height of the prism by the refractive index of the glass used. Common offsets are 0, -17.5 mm, -30 mm, -34 mm, and -40 mm.

### Nodal Offsets

A nodal offset is defined by the relationship of the prism holder and prism that places the optical center of the prism on the plumb line of the holder. This offset is the most advantageous at close range work when the apex or center of the prism is used as a pointing target for vertical and horizontal angle measurement. Every prism has a nodal offset. Prisms and holders that are not in the nodal position however, can cause angular errors when using the prism apex as a target if it is not perfectly pointed toward the measuring instrument.

To reduce pointing errors, several SECO prism assemblies are designed with a nodal point alignment at -17.5 (for 25-mm prisms) or -40 mm offset (for 62-mm prisms). See illustration at right.

Commonly, the best reading of the beam is achieved when the prism face is perpendicular to the incoming beam for a parallel return. Unfortunately, ideal alignment is not always achieved in the field.

To compensate for pointing errors, nodal point alignment minimizes the error associated with misalignments (two illustrations below).

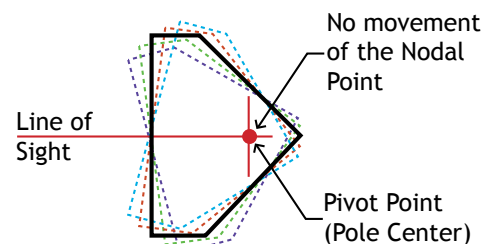

at -17.5 or -40 mm Offset

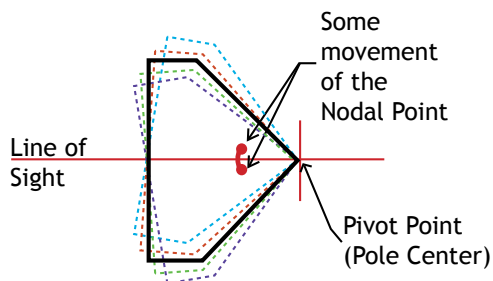

Non-Aligned at -30 mm Offset

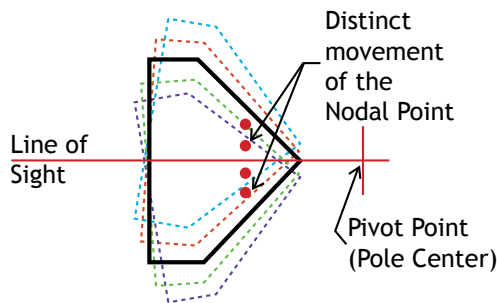

Non-Aligned at 0 mm Offset

### Prism Range

Corner cube prisms redirect the measuring beam back to the EDM for signal processing. There are two main factors for good range measurement: prism diameter and beam deviation. If the beam deviation is not accurate enough, the returned beam will miss the EDM entirely. This occurs mainly near the maximum range of the EDM (check with your manufacturer). SECO standard prisms are <math>\leq 5</math> seconds. Higher accuracy prisms are also available.

### Prism Holder Accuracy

Prism accuracy is determined by the physical location of the prism in its canister and then to its holder. SECO prism accuracy is 1 mm or less.

SECO uses a **ZYGO GPI-XP/D interferometer** to test and confirm the beam deviation of prisms to ensure that they meet specifications. Certificates of compliance are available upon request. Come see us for more details.



## Rear Locking 62-mm Premier Prism Assembly

This prism assembly design incorporates a simple stainless steel locking mechanism that's easy to set while adjusting the prism and target tilt. The heavy-duty 62-mm silver-coated prism is sealed in a strong canister with an 'O' ring to prevent water and dust from getting inside. The prism can be mounted in either 0 or -30-mm offset positions. Two target sizes and five color combinations are available, see below. The tilting axis height is 115 mm.

The 6402-20 weighs 1.75 lb (0.79 kg). The 6422-20 weighs 1.59 lb (0.72 kg).



*Rear locking mechanism makes sighting and tilt adjustment a breeze!*

Number:	Target Color:	Target Size:
6402-20-FOW	Flo Orange with White	6 x 9 in
6402-20-YLB	Yellow with Black	6 x 9 in
6402-20-FLB	Flo Yellow with Black	6 x 9 in
6402-20-FOB	Flo Orange with Black	6 x 9 in
6402-20-WHB	White with Black	6 x 9 in
6422-20-YLB	Yellow with Black	5.5 x 7 in
6422-20-FLB	Flo Yellow with Black	5.5 x 7 in
6422-20-FOB	Flo Orange with Black	5.5 x 7 in
6422-20-FOW	Flo Orange with White	5.5 x 7 in
6422-20-WHB	White with Black	5.5 x 7 in



## Rear Locking 62-mm Premier Prism Holder and Target

#6402-20-050-FOB

This prism holder and target is the same as above (minus the canister.)

Order the holder and target and your choice of canister on the right to create a custom set up!



**62-mm Nitrogen Filled Prism with Hermetically Sealed Canister**  
#6411-00

Features <5-second accuracy.



**62-mm Copper-Coated Prism with Sealed Canister**  
#6411-02-BLK

Features <5-second accuracy.



**62-mm Silver-Coated Prism with Heavy-Duty Sealed Canister**  
#6411-03-BLK

Features <5-second accuracy.



**62-mm Silver-Coated Prism with Heavy-Duty Sealed Canister**  
#6411-04-BLK

Features <2-second accuracy.



**62-mm Silver-Coated Strobe Prism**  
#6416-00

Features 0.5-second flash.



**58-mm Silver-Coated flexible Polycarbonate Prism**  
#2040-FOR (Orange shown, YEL and FLY also available)

Features <5-second accuracy.

# 62-mm Prisms and Assemblies



## Eclipse 62-mm Nodal Point Prism Assembly

#6400-00

The Eclipse™ prism assembly features a water-resistant, nitrogen-charged, 62-mm prism canister and reversible target.

It can be set at a -40 mm, which offers optimal angle measurements, even when tilting in either the horizontal or the vertical axis. A -30-mm adapter is included.

The height to center of glass: 0.38 ft (115 mm).

Weighs 1.15 lb (0.52 kg)



## 62-mm Nodal Point Prism Assembly

#6400-10

This assembly features three prism offset positions, 0, -30 and -40 (nodal). The 62-mm prism is silver coated and has a <5-second accuracy. The reversible target comes in orange & white and black & white.

The height to center of glass: 0.33 ft (100 mm).

Weighs 1.45 lb (0.66 kg)



## 62-mm Nodal Point Prism Assembly

#6406-00

This high-quality GPH1 Swiss-style prism assembly features a copper-coated prism for consistent results and a removable target.

It has a -34 mm-offset prism and an 86-mm 'HT'.

Weighs 0.92 lb (0.42 kg)



## Single Prism Tilting Assembly

#6440-00-FOR

This assembly consists of an aluminum -30-mm offset prism holder (#6375-00-FOR), coated with corrosion-proof powder paint, and a copper-coated 62-mm prism (#6411-02-BLK).

Available colors: yellow, fluorescent yellow, and fluorescent orange.

Weighs 1.5 lb (0.68 kg)

## 62-mm Prism with Non-Tilting Holder

#6440-10-FOR

This assembly consists of an aluminum -30-mm offset (or zero offset prism) holder and a 62-mm, copper-coated prism in a sealed canister.

Weighs 1.5 lb (0.68 kg)



## Premier 62-mm Prism Assembly

The Premier Prism Assembly features a copper-coated, canister-type prism. It's waterproof, and has an M20 universal mounting thread. The tilting holder is anodized aluminum and features an improved locking clamp screw design and an 18-gauge steel target. The prism can be mounted in either 0 or -30-mm offset positions.

The tilting axis height is 115 mm. The 6402-02 weighs 1.75 lb (0.79 kg). The 6422-02 weighs 1.59 lb (0.72 kg).



Number:	Target Color:	Target Size:
6402-02-FOW	Flo Orange with White	6 x 9 in
6402-02-YLB	Yellow with Black	6 x 9 in
6402-02-FLB	Flo Yellow with Black	6 x 9 in
6402-02-FOB	Flo Orange with Black	6 x 9 in
6402-02-WHB	White with Black	6 x 9 in
6422-02-YLB	Yellow with Black	5.5 x 7 in
6422-02-FLB	Flo Yellow with Black	5.5 x 7 in
6422-02-FOB	Flo Orange with Black	5.5 x 7 in
6422-02-FOW	Flo Orange with White	5.5 x 7 in
6422-02-WHB	White with Black	5.5 x 7 in

## Standard 62-mm Prism Assembly

The Standard Prism Assembly features a copper-coated, canister-type prism. It's waterproof and has a M20 universal mounting thread. The tilting holder is powder-painted die cast aluminum. It uses a simple but proven locking system. The prism can be mounted in either 0 or -30-mm offset positions. The tilting axis height is 115 mm. Weighs 1.35 lb (0.62 kg)



Number:	Target Color:	Target Size:
6402-10-YLB	Yellow with Black	5.5 x 7 in
6402-10-FLB	Flo Yellow with Black	5.5 x 7 in
6402-10-FOB	Flo Orange with Black	5.5 x 7 in

 Tech Tips available at [www.surveying.com](http://www.surveying.com)

## Tilting Triple Prism Assembly

#6341-00

This unit is made from orange polycarbonate with metal inserts and an aluminum yoke.

It holds one to three prisms, is compatible with most screw-in prisms, and has a 0 and -30-mm prism offset.

It has a peep sight for pointing the holder, perfect for longer distances. The H.T. is 97 mm.

It comes with three sealed copper 62-mm prisms in black canisters (#6411-02-BLK). Holder available separately (page 42). Weighs 2.7 lb (1.23 kg)



**Don't forget a bag for your new prism!**  
See bags and cases starting on page 72



# 58-mm Prism Assembly

Rugged aluminum powder-coated target.  
Dual-sided target, 0 and -30 mm offsets.  
Flo orange, flo yellow or standard yellow.  
Made in the USA.  
Limited lifetime warranty.



58 mm prism.  
<5 arc second deviation.  
Silver-coated prism.  
Polypropylene sealed canister.  
Impact resistant M20 threads.

Height of tilting axis is 115 mm.

Easy-to-use twist knob for tilting target

Precision manufactured anodized aluminum yoke.  
Made in the USA.  
Limited lifetime warranty.

Fits standard 5/8 x 11 prism poles or adapters.

## Universal Tilting Prism Assembly

The accuracy of the 58-mm prism is <5 arc second and is silver coated to protect against moisture, fogging and severe climatic conditions. The #2050 prism canister, holder, yoke and locking target assembly are manufactured in the United States and have a lifetime limited warranty. The rugged Polypropylene prism canister with brass M20 thread is highly impact resistant.

The dual sided targets have -30-mm and 0-mm offsets. The target and yoke assembly are precision manufactured from high quality aluminum, stainless steel and brass. It has an easy to use twist knob tilting target lock.

This assembly fits standard 5/8 x 11 prism poles, adapters, etc.

It is available in three high visibility powder coated colors: yellow, fluorescent orange, and fluorescent yellow.

The height of the tilting axis is 115 mm.

Weighs 1.5 lb (0.68 kg)

<b>Number:</b>	<b>Target Color:</b>	<b>Target Size:</b>
2050-YLB	Yellow with Black (shown)	4.5 x 4.5 in
2050-FLB	Flo Yellow with Black	4.5 x 4.5 in
2050-FOB	Flo Orange with Black (shown)	4.5 x 4.5 in

# 25-mm Prisms and Accessories



*Lightweight!*

## Tilting Mini Prism System

#6450-00-BLK — 0 and -30 Offset

The Eclipse™ mini system includes: a Mini Tilting Prism (#6451-00-BLK); plumb bob attachment; Mini Bob Prism Mount (#6453-00); Point (#6220-00), and Belt Case (#8022-00-CABLU).

Weighs 0.3 lb (0.14 kg)



## Stakeout Mini Prism with Site Cones

#6405-10-FOR — 0 and -30 Offset (shown)  
#6405-12-FOR — -17.5 Nodal Offset

This prism features 'site cones' that improve vertical angle pointing and an adjustable side-mounted circular vial. The site cones double as tilting-axis lock knobs.

The adjustable 40-min vial is mounted on the front side and is easy to see and adjust.

Weighs 0.3 lb (0.14 kg)



## 25-mm Stakeout Prism Assembly

#6405-01-FOR — 0 and -30 Offset (shown)  
#6405-04-FOR — -34 mm Offset

This 25-mm, copper-coated prism features double yoke construction w/tilting coaxial target.

There are two on-board 130-minute vials, top & bottom. It includes replaceable plumb bob point.

Also in yellow and flo yellow.

Weighs 0.62 lb (0.28 kg)

## Mini Prism System

#6200-10-FOR — with Center Vial  
#6200-11-FOR — with Side Vial (shown)

This system contains a copper coated 25-mm prism; a tilting holder (0, -30 mm offset) with center or side-mounted 40-minute vial; 100 and 115-mm adapters for pole or tribrach mounting (prism holder height, w/o adapters is 70 mm); S-hook and bracket for hand-held work; a point for stake-outs (97 mm height); and a padded system bag for carrying it all.

Weighs 0.34 lb (0.15 kg)



## Stakeout Mini Prism Kit

#6405-11-FOR — 0 and -30 Offset

The white site cones on X and Y axis of the assembly help improve centering of your instrument's crosshairs for vertical and horizontal pointing.

It can be used in four height configurations: 50 mm, 100 mm, 115 mm and 150 mm, top or bottom of the pole, handheld, or tribrach mounted.

Weighs 0.8 lb (0.36 kg) and 1.3 lb (0.59 kg) with heavy-duty point.



## Nodal Point Stakeout Mini Prism Kit

#6405-13-FOR — -17.5 Nodal Offset

The popular SECO stakeout prism (above) is now in 'kit' form. The prism features a -17.5-mm offset. The white site cones on the X and Y axes help centering instrument crosshairs. The heavy-duty point can handle the abuse on the bottom of a pole.

The white adapter is used to make the prism height 115 mm for use with most standard prism poles.

Weighs 0.8 lb (0.36 kg) and 1.3 lb (0.59 kg) with heavy-duty point.



# 25-mm Prisms and Pin Pole Kits

## Euro-Style Prism Pole Systems

#5910-01-ARD — 0 and -30 Offset  
#5910-02-ARD — -17.5 Nodal Offset  
#5910-03-ARD — -34 Offset

This system is ideal for all handheld prism work, topos or precise layout work; it can be assembled in various configurations.

It's available with the most accurate offset position (-17.5 mm — nodal) that places the optical center of the prism over the plumb line axis. This helps eliminate angular pointing errors, at close range.

All anodized aluminum section lengths are known (30 cm). It features a 40-minute adjustable vial and white sight cones and comes with a 5/8 x 11 adapter for standard prism poles (for height of 115 mm).

An orange Cordura® carrying case is also included.

Weighs 1.60 lb (0.73 kg)

## Sliding Prism and Sectional Pole Kit

#5910-05 — Feet, 0 Offset (shown)  
#5910-06 — Metric, 0 Offset

This system tilts and slides up and down pin poles.

It features a 25-mm, 0 offset silver-coated prism and a high-quality aluminum holder.

The site cones double as locks.

The prism has a 40-minute adjustable vial.

The kit includes four 1-foot (30.5-cm) pole sections each with a 0.50-ft (15.24-cm) mark.

This prism includes an adapter so it can be used on any pole or tribrach adapter with 5/8 x 11 threads. A system bag is also included.

More information can be found online at [surveying.com](http://surveying.com)!

Weighs 1.40 lb (0.63 kg)

## Pin Pole with Sliding 25 mm Prism System

#6600-10

This 12.2-mm OD pin pole features three sections - each 60 cm in length to achieve 1.8 m (5.91 ft); each color section (red or white) is 10 cm in length.

Perfect for use with the Alligator Clamp Tripod (page 32).

Weighs 1.95 lb (0.9 kg)



 Demo video available at [www.surveying.com](http://www.surveying.com)

## Reflector Pin Pole Kit

#5910-10

This new Reflector Pin Pole kit is ideal for use with reflectorless total station instruments.

The target holder is machined anodized aluminum and allows the target to tilt 360°. A 40-minute vial is built in.

Comes with four aluminum 30 cm pole sections, prism and system case.

The 5 cm point is a special three piece non-conductive design.

Weighs 1.45 lb (0.66 kg)

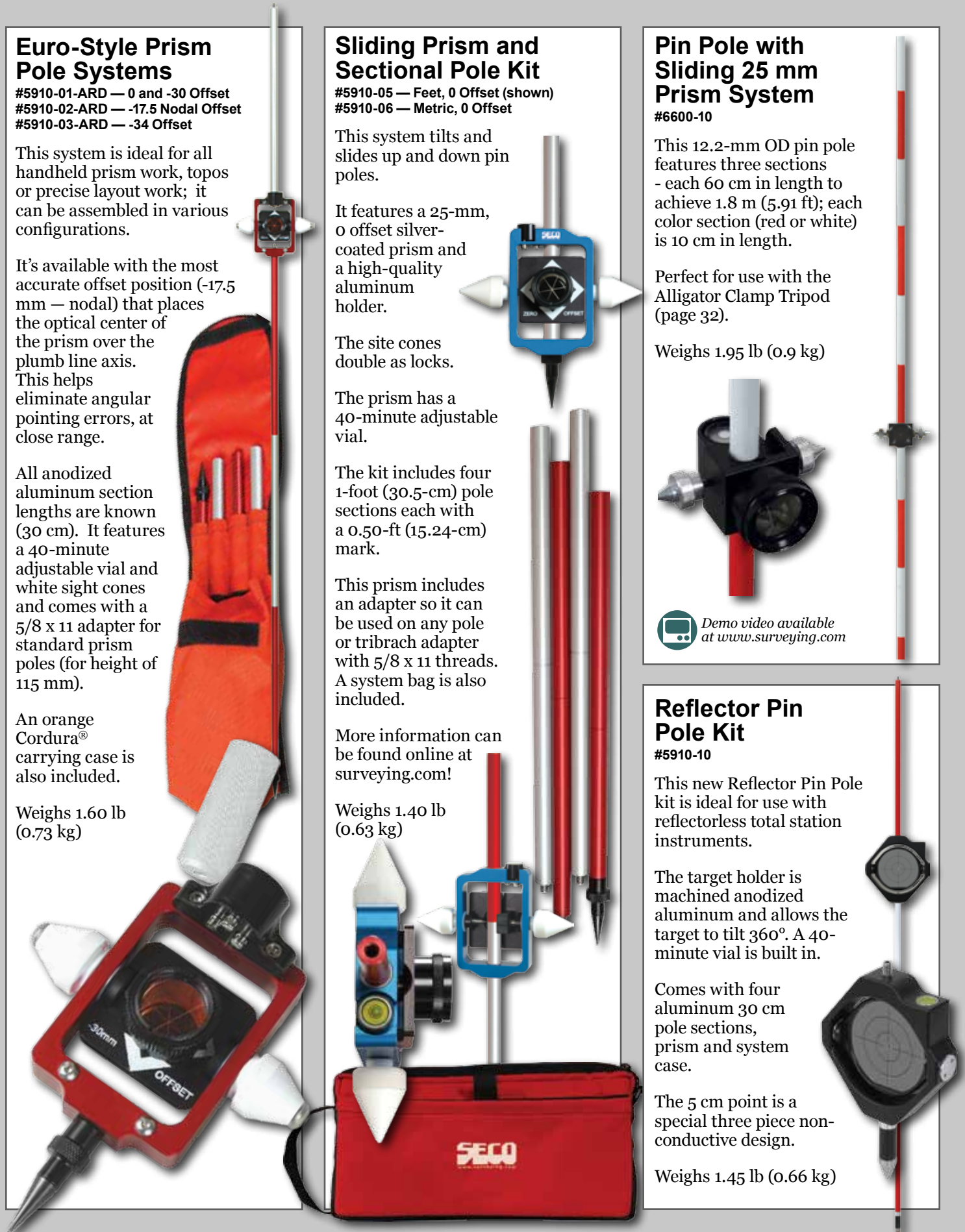



## Sliding 360° Prism Kit

#5910-20 — Metric (shown)  
#5910-21 — Feet



The prism assembly on SECO's #5910-20 360° prism kit slides on 9-mm-diameter solid steel pin poles.

The assembly is composed of seven 12.7-mm-diameter silver-coated mini prisms in a 360° configuration.

It features a +2-mm offset and a 40-minute adjustable circular vial.

A clamp screw locks the prism assembly anywhere on the pole.

The four 30-cm (#5910-21, 1-foot) pole sections feature alternating colors at 5-cm (#5910-21, 1-foot) intervals. They connect to achieve heights from 7.5 to 125 cm (#5910-21, 0.25 to 3.85 ft in 0.20 ft increments.)

A spring-loaded ball detent adds tension, keeping the prism from falling when unlocked. It also centers and locks the assembly into the grooves between each color interval.

A stainless steel point, data collector adapter and carrying case are included.

Weights 1.76 lb (0.80 kg)



## Sliding Mini Prism Kit

#5910-07M — Metric, -17.5 Offset (shown)  
#5910-07F — Feet, -17.5 Offset  
#5910-08M — Metric, -30 Offset  
#5910-08F — Feet, -30 Offset



These prism holders allow 'non-zero' prism offsets to 'slide' and are available in -17.5 mm or -30 mm offsets.

They come equipped with a 25 mm silver-coated mini prism and height scales built into the holder frames.

They have a sliding range of 0.50-foot (15 cm).

The mini prism assembly can be removed and used normally for other jobs.

Three 1-foot (30 cm) extensions and one 0.50-foot (15 cm) extension are included.

They feature stainless steel points and 20 minute adjustable circular vials.

The #5910-07 and #5910-08 are precision machined from aluminum and stainless steel parts.

Included is a 5/8 x 11 adapter for use with tribrachs or poles.

System Bag included.

Weights 3 lb (1.4 kg)



# Other Prisms and Accessories

## Premier 62-mm Strobe Prism Assembly

#6402-03-FOR — 6 x 9 inch target (fluorescent orange shown)

This assembly combines the SECO Premier target and holder with a strobe prism.

It's perfect for low light conditions.

The silver-coated prism flashes every 0.5 second.

Weighs 1.35 lb (0.61 kg)



## Standard 62-mm Strobe Prism Assembly

#6402-11-FOR — 5.5 x 7 inch target (flo orange shown)

This assembly combines the SECO Standard target and holder with a strobe prism.

It's perfect for low light conditions.

The silver-coated prism flashes every 0.5 second.

Also available in flo yellow and standard yellow.

Weighs 1.4 lb (0.64 kg)



## Tilting Triple Prism Holder

#6341-10

This assembly is made from orange polycarbonate, four metal inserts and an aluminum yoke. It can hold one to three standard screw-in 62-mm prisms.

The housing features a peep sight to assist with longer distances.

Weighs 0.91 lb (0.41 kg)



## Non-Tilting Prism Holder

#6380-00-FOR

The holder is designed for use with screw-in 62-mm canisters and features both 0 and -30-mm offsets and a 5/8 x 11 threaded base. The height from the base of the prism to the center of glass is 115 mm (4.52 in).

Available colors: yellow, fluorescent yellow, and fluorescent orange.

Weighs 0.80 lb (0.36 kg)



## Other Prism Accessories Available

Number:	Product Description:
6020-01	25-mm mini prism in a canister
6030-01	Plumb bob bracket, -34-mm offset
6341-11	Tilting triple prism target
6402-10-050-FOR	Standard prism holder (for 6402-10-FOR)
6403-02-FOB	Premier prism holder with 6 x 9-inch target, 0 and -30-mm offset
6410-00	Prism holder, -30 mm, -40 mm offset (for 6400-00)
6410-018	0 offset adapter for #6400-00
6423-02-FOB	Premier prism holder with 5.5 x 7-inch target, 0 and -30-mm offset



## Walleye Prism System

- #6603-00 — Complete System with #6411-03-BLK Prism and 5/8 x 11 Adapter
- #6603-01 — Complete System with #6411-03-BLK Prism and M8 Adapter
- #6603-00-050 — L-Bracket Assembly Only
- #6603-00-050-TMB — Rain Hood Only
- #6603-00-051 — 5/8 x 11 Adapter with Screw and Washer
- #6603-01-051 — M8 Adapter with Screw and Washer



This system accommodates a full size 62 mm prism for long range applications or when a larger prism is needed. The rain hood helps keep the prism clean to ensure continual measurements over a long measuring cycle. Components available individually so you can configure your specific needs. The flat bottom of the L-Bracket is a large 2.3 x 3.4 inches with five holes for mounting to a variety of surfaces. Center pivot hole is 3/8-inch (9.5 mm), the four screw holes are 11/64-inch (4.5 mm) OD.

Features include a -40 mm offset,  $\pm 2$  mm, ability to pivot in two axes, stainless-steel locking. The system is compatible with all M20 screw-in type prism canisters. System weighs 1.55 lb (0.7 kg)

## Small, Lightweight Tilting Reflectors

- #6600-01 — Diamond Pattern (shown)
- #6600-03 — Diamond Pattern w/ Crosshairs
- #6600-04 — 25-mm Mini Prism

The #6600-01 (shown) and -03 feature a 60 mm diamond pattern sheeting and a 2 mm offset. Use for distances up to 492 ft (15 m).

The #6600-04 features a 25 mm mini prism for longer distances up to 2,000 ft (600 m).

All three models feature an 86 mm height and fit Swiss-style male tips or Quick Release adapters (below).



## 25-mm 'L-Bar' Mini Prism

#6600-02

The 25-mm 'L-Bar' is perfect for deformation or mining surveys, or places where a permanent mounting is needed.

This assembly is constructed of anodized aluminum and the prism is water and dust proof. It features a -25-mm offset and comes with 10.3-mm ID mounting hole.

Weights 0.45 lb (0.20 kg)



## Stainless Steel Quick Release Adapters

6601-Series Quick Release Adapters are made of T-303 stainless steel with machined threads that attach to corresponding Anchor Bolts or the 6602-Series rebar bolts. Weighs 0.10 lb (0.05 kg)



#6601-01  
1/4 x 20 threads



#6601-02  
3/8 x 16 threads



#6601-03  
M8 threads



#6601-04  
M12 threads

## Anodized Quick Release Adapter

#5187-00

This adapter features female 5/8 x 11 threads. It's made of anodized aluminum.

Weights 0.05 lb (0.02 kg)



## Rebar Bolts

- #6602-01 — 3/8 x 16 threads
- #6602-02 — M12 Threads
- #6602-03 — M8 threads

Rebar Bolt measures 3/4 x 9.9 in (19.05 x 251.46 mm) long comes with a hex bolt used to hammer the bolt in the surface, remove the hex bolt and install the 6601-Series Adapter. Choose between 3/8 x 16 or M12 thread patterns. Weighs 1.25 lb (0.57 kg)



# Tribrachs and Adapters

## European-Style Tribrachs

#2152-05-BLK — with Optical Plummet

#2152-06-BLK — with Optical Plummet

(High Precision < 3 cc Hysteresis)



#2153-05-BLK — without Optical Plummet

#2153-06-BLK — without Optical Plummet

(High Precision < 3 cc Hysteresis)



These high-quality tribrachs are available with or without an optical plummet.

The #2152-06-BLK and #2153-06-BLK are high-precision tribrachs designed to work with all total stations including the Trimble® S6 Robotic Total Station.

The #2152-05-BLK and #2152-06-BLK with optical plummet, feature 2X magnification and a twist focus. The reticule is composed of two small concentric circles. With a sighting distance of 0.3 m (0.35 m for #2152-06-BLK) to 15 m, the tribrach has an accuracy of 0.5 mm per 1.5 m.

These tribrachs have a locking forced-centering knob, a 5/8 x 11 base and an 8-minute circular vial.

The operating temperature for these tribrachs is -20°C to +50°C (-4°F to +122°F)

Each weigh approximately 1.55 lb (0.70 kg)



## Laser Tribrach

#2153-02-BLK

This tribrach has a bright 650-nm focused laser dot that provides prompt and precise positioning over a point.

It has a push-button on/off switch which is now located close to the tribrach body to prevent it from accidentally turning on during transport or handling.

This tribrach has a circular vial w/8-minute sensitivity. It has standard three prong forced centering with center lines on the leveling screw range. Included is a standard 3 volt CR2 Panasonic lithium battery providing 10 hours of continuous operation.

Weighs 1.65 lb (0.75 kg)



## Optical Plummet Twist Focus Tribrach

#2152-04-YEL

The Optical Plummet Twist Focus Tribrach features twist focus (2.5X mag) and leveling screws with center line. It has an 8-min vial, 3-prong forced centering and a 5/8 x 11 base.

This tribrach has a focusing range of 1.5 to 50 feet (0.5 to 15 m).

Available in black, green, yellow (shown) or grey.

Weighs 1.85 lb (0.84 kg)



## Fixed Tribrach Adapter

#2010-00

Use this adapter for mounting retro prisms and tripod mounted target systems. Fits all tribrachs.

Weighs 0.5 lb (0.23 kg)



## Rotating Tribrach Adapter

#2020-00

This rotating friction top tribrach adapter allows the prism to be pointed after installation in the tribrach. Fits all tribrachs.

Weighs 0.9 lb (0.41 kg)



## Rotating Tribrach Adapter

#2070-00

This adapts retro prisms to Swiss-style tribrachs and has a removable Zeiss plug and locking screw. Fits all tribrachs.

Weighs 1.75 lb (0.8 kg)



## Prism H.T. Adapter

#2071-00

This allows adjusting of prism height by moving the threaded brass insert in the adapter. Fits all tribrachs.

Weighs 1.91 lb (0.87 kg)



## Horizontal Base

#2021-00

The Horizontal Base will accept any 5/8 x 11 instrument and features a precision brass slow-motion tangent screw. It's great for dual-axis lasers. Fits all tribrachs.

Weighs 3 lb (1.36 kg)



## Tribrach Adjusting Cylinder

#2001-00

Use for checking and adjusting optical plummet tribrachs in the office. Precision-machined, black anodized aluminum.

Weighs 0.7 lb (0.32 kg)



## Tribrach Adjuster

#2002-00

Use for adjusting optical plummet tribrachs & tribrach bubbles. The machined black anodized aluminum features a 2-minute bubble.

Weighs 1.3 lb (0.59 kg)



## Tribrach Case

#8071-00-ORG

This padded carrying case for tribrachs has a heavy-duty zipper, dust flaps & nylon carrying straps.

Measures 6 x 6 x 2 in (15.24 x 15.24 x 5.08 cm)

Weighs 0.40 lb (0.18 kg)



Tech Tips available at [www.surveying.com](http://www.surveying.com)

# Tribrachs and Adapters

## Traverse Kit for 196 mm Heights

#2159-03-BLK

This Traverse Kit is preset to a 196 mm height making it compatible with the Trimble® S6 and the Spectra Precision Focus 30 instruments. It can also be adjusted for taller instruments ranging from 196 mm to 216 mm heights.

This traverse (or precise backsight) kit includes a 62 mm prism assembly (#6402-22-YLB) with a <math><5</math> arc seconds angle deviation and a silver-coated prism to resist fogging. The adjustable tilt target has 0 or -30 offsets.

The kit comes with a rotating tribrach adapter (#2153-10-BLK) with a 2.5X twist focus optical plummet and a 60-second adjustable plate vial. The adapter has a precision machined axis that rotates 360 degrees. Over the point accuracy is 0.5 mm at 1.5 m.

Also included is a European-made tribrach (#2153-06-BLK) which features three-screw-leveling with center line, an 8-minute circular vial, and 5/8 x 11 base thread. Works with all S6-type instruments.

This kit comes with a bright orange, hard shell carrying case (#2159-050) with high density foam inserts, nickel plated latches and backpack straps.

Weighs 9.95 lb (4.51 kg)



## Traverse Kit for 155 mm Heights

#2159-04-BLK

This Traverse Kit is preset to a 155 mm height making it compatible with Nikon NIVO™ Series Total Stations.

This traverse (or precise backsight) kit includes a 62 mm prism assembly (#6402-04-YLB) with a <math><5</math> arc seconds angle deviation and a silver-coated prism to resist fogging. The adjustable tilt target has 0 or -30 offsets.

The kit comes with a rotating tribrach adapter (#2153-11-BLK) with a 2.5X pull focus optical plummet and a 60-second adjustable plate vial. The adapter has a precision machined axis that rotates 360 degrees. Over the point accuracy is 0.5 mm at 1.5 m.

Also included is a #2153-04-BLK tribrach which features three-screw-leveling with center line, an 8-minute circular vial, and 5/8 x 11 base thread.

This kit comes with a bright orange, hard shell carrying case (#2159-050) with high density foam inserts, nickel plated latches and backpack straps.

Weighs 9.95 lb (4.51 kg)



# Tribrachs and Adapters



## Traverse Tribrach Adapter

#2153-10-GRY

This Tribrach Adapter is for traversing or precise setups. The optical plummet is twist-focus with 2.5X magnification. It has a 60-second adjustable plate vial. The precision-machined axis rotates 360 degrees.

This adapter is compatible with all prisms with a 24.9-mm bayonet base. The adjustable height is 100 mm-to-120 mm. It fits all standard three-prong tribrachs. The over point accuracy is 0.5 mm at 1.5 m. Other available colors are black, yellow and green.

Weights 1.70 lb (0.77 kg)



#2153-10-050  
Male 5/8 X 11  
Adapter

#2153-10-051  
Quick Release  
Adapter

## Traverse Kit

#2159-01-GRY — With Single Prism (shown)

#2159-02-GRY — With Triple Prism

This traverse (or precise backsight) kit includes a 62-mm prism assembly (#6400-10). The prism canister is silver coated to resist fogging and the prism has <math><5</math> arc seconds angle deviation. The adjustable tilt target has 0, -30, and -40 prism offsets and is reversible; orange/white and black/white. The target also has a sighting collimator for precise pointing.

The kit comes with a rotating tribrach adapter (#2153-10-GRY) that is compatible with all prisms with a 24.9-mm bayonet base. It has a 2.5X twist focus optical plummet and a 60-second adjustable plate vial.

The adapter has a precision machined axis that rotates 360 degrees. The height is 100-to-120 mm and over the point accuracy is 0.5 mm at 1.5 m.

Also included is a tribrach (#2153-04-GRY) which features three-screw-leveling with center line, an 8-minute circular vial, and 5/8 x 11 base thread.

This kit also comes with a bright orange, hard shell carrying case (#2159-050) with high density foam inserts, nickel plated latches and backpack straps.

This kit is also available without a prism (#2159-00). The tribrach and adapter come in gray, green, yellow or black.

Weights 9.95 lb (4.51 kg)



# Instrument Tripods

These aluminum instrument tripods accommodate 5/8 x 11 instruments and are ideal for mounting lasers, total stations and auto levels. The telescopic legs allow for setup at various heights and are available in aluminum with orange or black hardware (on some models).



	<i>Number:</i>	<i>Lock Type:</i>	<i>Legs:</i>	<i>Weight:</i>	<i>Extension:</i>	<i>Head:</i>	<i>Hardware:</i>
<b>A</b>	5301-20-ORG	Quick Clamp	Aluminum	10.2 lb (4.63 kg)	66 in (1.70 m)	Flat	Orange or Black
<b>B</b>	5311-20-ORG	Quick Clamp	Aluminum	10.2 lb (4.63 kg)	66 in (1.70 m)	Dome	Orange
<b>C</b>	5401-20-ORG	Twisting Lock	Aluminum	10.2 lb (4.63 kg)	66 in (1.70 m)	Flat	Orange or Black
<b>D</b>	5301-27-BLK	Quick Clamp	Aluminum	7 lb (3.18 kg)	65 in (1.60 m)	Flat	Black or Orange
<b>E</b>	5321-16-BLK	Quick Clamp	Aluminum	15 lb (6.80 kg)	91.2 in (2.32 m)	Elevator	Black
<b>F</b>	5401-23-BLK	Twisting Lock	Aluminum	6.70 lb (3.03 kg)	25.5 in (64.77 cm)	Flat	Black



# Instrument Tripods

These heavy-duty aluminum tripods offer stability and accuracy. They are built to last with heavy construction throughout, and are designed to withstand rigorous field conditions. They feature both quick clamp and screw clamp models in flat or dome head, and these tripods come equipped with square outer dowels for a more secure lock. These tripods are equipped with a 5/8 x 11 thread adapter for convenient mounting of instruments.



Number:	Lock Type:	Legs:	Weight:	Extension:	Head:	Hardware:
G 5301-30-ORG	Quick Clamp	Aluminum/Square Legs	10.1 lb (4.58 kg)	67 in (1.70 m)	Flat	Orange or Black
H 5311-30-ORG	Quick Clamp	Aluminum/Square Legs	10.1 lb (4.58 kg)	67 in (1.70 m)	Dome	Orange or Black
I 5401-30-BLK	Screw Clamp	Aluminum/Square Legs	10.1 lb (4.58 kg)	67 in (1.70 m)	Flat	Black or Orange

## Extra-Large Tripod Bag

#8154-11-ORG

This heavy-duty bag will carry many different brands of tripods, including SECO and Crain Tri-Max.

It measures 8 x 48 inches (20.3 x 121.9 cm).

Weighs 1.7 lb (0.77 kg)



# Instrument Tripods

## Tri-Max Tripod

#90550 (shown)

The Tri-Max® by Crain is without a doubt the best instrument tripod on the market today. It's the only surveying-grade tripod with certified accuracy – highly recommended for all servo-driven and robotic total stations and 3-D laser scanners.

This tripod easily meets the ISO 12858-2-H standard for the stability of instrument tripods. The revolutionary design of this tripod series and Crain's commitment to quality mean this tripod will meet the ISO standard right out of the box, and after years of field use.

The Tri-Max features a 6-5/8-inch head with large center hole (2-5/8 inch) to facilitate an easy set-up over a point.

A retaining system—which prevents leg kick out and accidental falls on slick surfaces— is stored on the inside of the leg and can be left in place when the tripod is not in use.

The Tri-Max features an advanced foot design. The large 'footbed' is there to facilitate solid planting for stability. The shape and size of the foot are designed to allow for a solid placement on any terrain. The foot is equipped with a replaceable point and a retention loop for use with a safety strap.

The Tri-Max can handle equipment up to 65 lb (30 kg)!



Demo video available at [www.surveying.com](http://www.surveying.com)



*The Quick-Clamp positive locking system can be placed on the inside of the leg if needed.*



*The Tri-Max foot plants firmly and holds tight.*



Number:	Lock Type:	Legs:	Weight:	Extension:	Head:	Hardware:
90550	Quick Clamp	Fiberglass	17 lb (7.7 kg)	71 in (1.8 m)	Flat	Black
90551	Screw Clamp	Fiberglass	17 lb (7.7 kg)	71 in (1.8 m)	Flat	Black
90553	Dual Clamp	Fiberglass	17 lb (7.7 kg)	71 in (1.8 m)	Flat	Black
90560	Quick/Dual Clamp	Fiberglass	20 lb (9.0 kg)	91 in (2.3 m)	Flat	Black
90561	Screw/Dual Clamp	Fiberglass	20 lb (9.0 kg)	91 in (2.3 m)	Flat	Black
90570	Fixed Leg	Fiberglass	17 lb (7.7 kg)	54 in (1.3 m)	Flat	Black

## Tri-Max Tripod 5-Inch Points

#91702 — 3 count

For use in soft terrains, such as mud and swampy areas.

The longer point allows for the tripod to be more firmly planted in the ground.

Weighs 0.9 lb (0.4 kg)



## Tri-Max Tripod Snow Plates

#91703 — 3 count

Snow plates widen foothold area for more secure planting in harder surfaces, like ice or snow. Tri-Max feet have a dimple in the center of the foot pad.

Drill out using a 3/8-inch bit and then attach bolt clamp from underneath. Place the plate over top and secure with screw knob. Weighs 2.17 lb (0.98 kg)

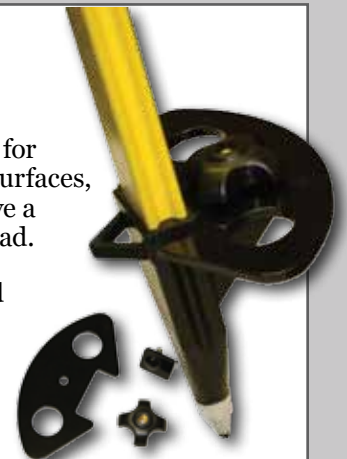

## Tri-Max Fiberglass Elevator Tripod

#90556

The Crain Tri-Max® Elevator Tripod features sturdy fiberglass legs with dual locks — a quick lever style at the top and a twist lock on the bottom. Built-in stabilizing struts connect the legs and aluminum center column to help maintain the tripod's stability at working height. The round 5/8 x 11 mounting head is removable and adjustable in azimuth direction. Other features include a stout gear box which controls lift and descent — the column can not fall freely.

The working height range (legs in tripod form as shown) is 4.92 ft (1.5 m) collapsed to 11.54 ft (3.52 m) extended with the center column at full height. The center column independently lifts 1.12 meters (graduated in millimeters). Completely collapsed for storage or transport, the tripod measures 5.35 ft (1.63 m) and will fit in the Extra Large Tripod Bag shown below.

Weighs 29 lb (13.2 kg)



## Heavy-Duty, Extra Tall, Fiberglass Elevator Tripod

#5321-17-ORG

This heavy-duty tripod features sturdy fiberglass legs with dual locks — a quick lever style at the top and a twist lock on the bottom. Built-in stabilizing struts connect the legs to the aluminum center column to maintain the tripod's stability at working height. The round 5/8 x 11 mounting head is removable and adjustable in azimuth direction. This tripod also includes both metal and rubber leg points and a handy carrying strap.

The working height range (legs in tripod form as shown) is 5.61 ft (1.71 m) collapsed to 12.47 ft (3.80 m) extended with the center column at full height. The center column independently lifts 1.12 meters (graduated in millimeters). Completely collapsed for storage or transport, the tripod measures 5.97 ft (1.82 m) and will fit in the Extra Large Tripod Bag shown below.

Weighs 31.5 lb (14.3 kg)

### Extra Large Tripod Bag — #8153-10-ORG

The bag features a full-length zipper and shoulder strap. Measures: 82 x 9 OD inches (208.28 x 22.86 OD cm).

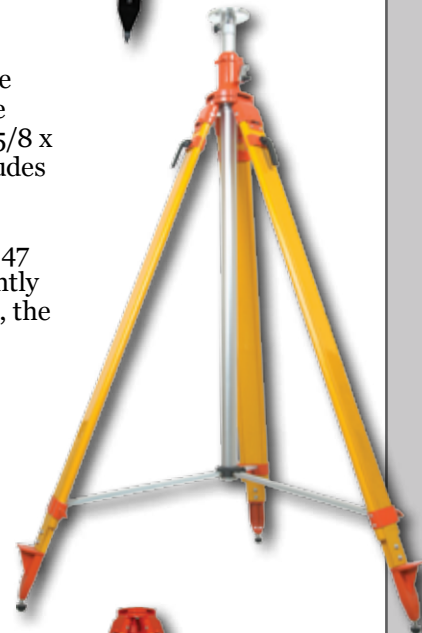

## Portable 11-Foot Fiberglass Tripod

#5203-20-ORG

This tripod is very portable; it breaks down in two, 4-foot sections.

It's easy to setup and take apart and comes with two carrying cases. Add the three additional legs and this tripod goes from 7 ft collapsed to 11 ft extended!

The tripod features a unique telescoping strut system to stabilize the fiberglass legs, dual clamps on each leg, and a flat head with standard 5/8 x 11 instrument fastener. It's waterproof and ideal for machine control, scanning, AG leveling or robotic applications where a taller platform is required.

Weighs 36 lb (16.3 kg)

*Includes bags for transporting or storage*



*Telescoping struts prevent leg movement!*

# Instrument Tripods

## Premier Heavy-Duty Wood Tripod with Round Head

#5220-10-BLK

Features include wood legs with a hand hole; 6.5-inch round head; quick-release and twisting locks; a leg stabilizer strap and tool kit.

The legs extend to 72 inches (182.8 cm), and collapse to 46.5 inches (118 cm).

Weighs 16.5 lb (7.48 kg)

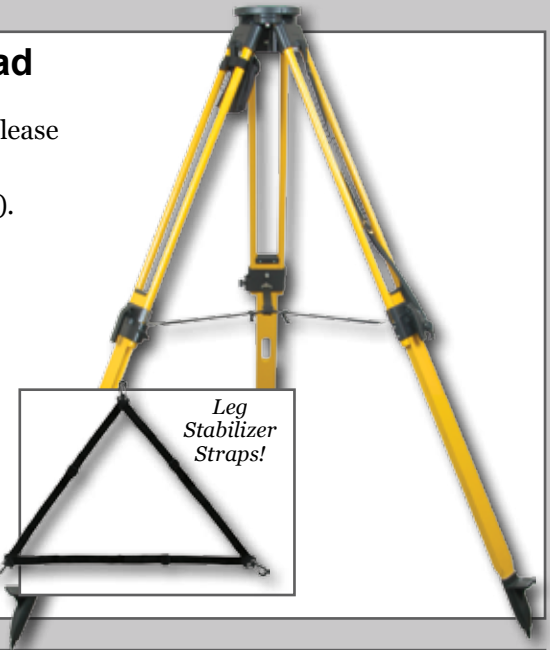
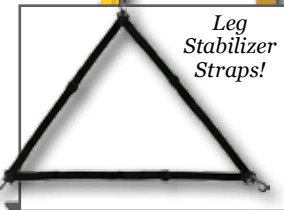
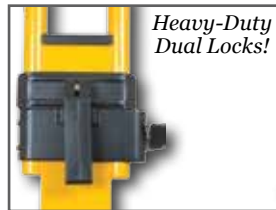
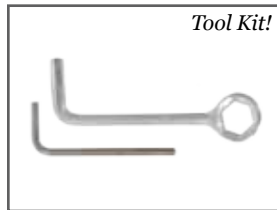

## Premier Heavy-Duty Wood Tripod with Round Head and Quick Clamp Legs

#5320-10-ORG (Choose orange, shown, or black hardware)

This new heavy-duty tripod features a round head for 5/8 x 11 instruments, all-wood legs with Quick Clamps and a hand hole.

The tripod extends to 72 inches (183 cm), and collapses to 46.5 inches (118 cm).

A shoulder strap is included for convenient carrying and the package includes a tool kit and a stabilizing strap. Weighs 16.5 lb (7.48 kg)

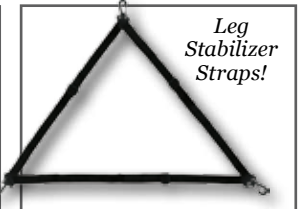
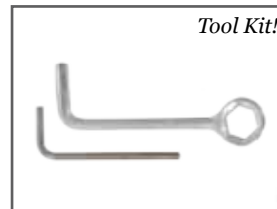

## Premier Heavy-Duty Wood Tripod with Round Head and Twisting Lock Legs

#5420-10-ORG (Choose orange, shown, or black hardware)

This new heavy-duty tripod features a round head for 5/8 x 11 instruments, all-wood legs with twisting locks and a hand hole.

The tripod extends to 72 inches (183 cm), and collapses to 46.5 inches (118 cm).

A shoulder strap is included for convenient carrying and the package includes a tool kit and a stabilizing strap.

Weighs 16.5 lb (7.48 kg)

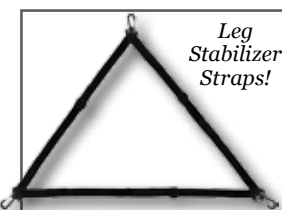
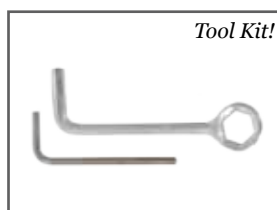

These Wood and Fiberglass Tripods are stable and accurate. They're perfect for mechanically-driven total stations and survey-grade theodolites and levels. More stable than aluminum tripods, these tripods stand up to demanding field conditions. The 5/8 x 11 threaded post accommodates standard instruments — an ideal tripod for many applications.



	<b>Number:</b>	<b>Lock Type:</b>	<b>Legs:</b>	<b>Weight:</b>	<b>Extension:</b>	<b>Head:</b>	<b>Hardware:</b>
<b>A</b>	5302-10-BLK	Quick Clamp	Wood/Fiberglass	18 lb (8.16 kg)	72.5 in (1.8 m)	Triangle	Black or Orange
<b>B</b>	5402-10-BLK	Screw Clamp	Wood/Fiberglass	18 lb (8.16 kg)	72.5 in (1.8 m)	Triangle	Black or Orange
<b>C</b>	5203-10-BLK	Dual Clamp	Fiberglass	18.2 lb (8.26 kg)	72.5 in (1.8 m)	Round	Black or Orange

## Tripod Bag

#8150-00-ORG  
#8150-20-ORG — with Rhinotek (shown)

The tripod bag holds all major brands of aluminum, fiberglass, and wood tripods. It's made of heavy-duty nylon Cordura®.

Both models feature drawstring closures and interior leather bottoms. The #8150-20 (shown) has a Rhinotek™ outer reinforced bottom.

It measures 52 x 8.75 inches (132.1 x 22.23 cm).

Weighs 0.26 lb (0.57 kg)



## Tripod Hard Shell Shipping Case

#8160-30

This is an ideal case to ship any surveying tripod.

It has 2 inches (5.08 cm) of padding inside the top and the bottom and a built-in hard plastic disc to keep tripod points from damaging the case.

It fits most standard height surveying instrument tripods and GPS base station tripods too.

This case is made of durable rotational molded cross linked safety orange polyethylene and comes with a life-time warranty and is UV stable.

The inside dimensions are 9 x 50 inches (22.86 x 127 cm) and is adjustable to 54 inches (137.2 cm). This case has a strong carrying handle and a 2-inch (5.08-cm) wide web belt with quick release buckle to hold and release lid.

It also boasts an ID card holder and shipping label area.

Weighs 18 lb (8.16 kg)



# Instrument Tripod Accessories

## Sta-Level Feet Tripod Stabilizers

#5610-10  
#5610-11 (w/ Rubber Pad)

Lightweight and portable, Sta-Level™ Feet keep your tripod level in all surface conditions.

Position the feet on the ground, set the tripod points in the center divot of each foot and level the tripod. Set of three - each weighs 0.29 lb (0.12 kg)



## Tripod Collector Bracket

#5196-01

Designed for TSCe,™ Ranger,™ FS Series collectors. This bracket is fully adjustable. Weighs 0.98 lb (0.44 kg)



*Other collector brackets are available. See us for details!*

## Tripod Hook Brackets

#5196-14 — For Ranger 300X, 500X, TSC2  
#5196-15 — For Recon  
#5196-16 — Archer  
#5196-17 — Nomad  
#5196-18 — TSC3, Ranger3

SECO has four solutions to secure your TDS™ Ranger 300X/500X, Trimble® TSC2™, Recon®, Archer® or Nomad® controller to a surveying tripod.

*Both include instructions and a tool for installation!*



## Tilted Tripod Bracket

#5196-07

This tilted SECO bracket holds the Allegro, Archer®, Explorer, Recon® or Jett®•ce controller to a SECO or any similar brand tripod. Weighs 0.06 lb (0.03 kg)

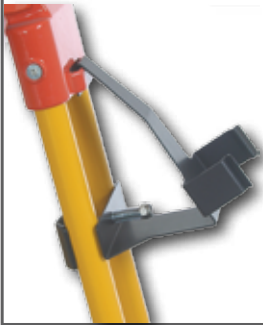

## Tripod Stabilizer

#5610-00

The tripod stabilizer is designed to provide the extra stability required when working indoors on concrete and other hard surfaces. It's made of heavy-duty aluminum and measures 35 x 35 x 35 in (88.9 x 88.9 x 88.9 cm). It collapses for compact storage. Weighs 3 lb (1.36 kg)

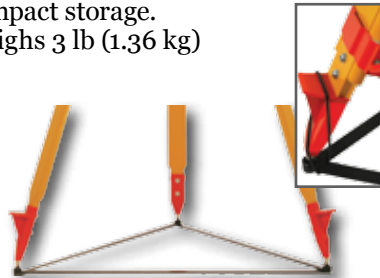

## Tripod Bracket

#5196-04

This economy model bracket fits snug on a tripod and holds the Allegro, Archer®, Explorer, Recon® or Jett®•ce controller to a SECO or any similar brand tripod.

Weighs 0.05 lb (0.02 kg)

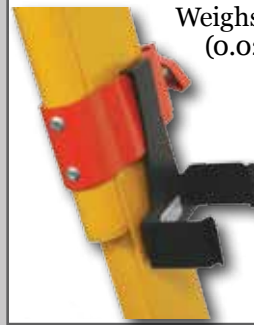

## Rotating Tripod Bracket

#5196-13  
#5196-13-005 — Brass Adapter

This aluminum bracket rotates around the tripod head for easier access to your collector. It's perfect for layout work or large topo surveys!

Weighs 1.8 lb (0.8 kg)



## Tripod Adapters

#2120-00: Adapts 3-1/2 x 8 tripod to 5/8 x 11.

#2130-00: Adapts 5/8 x 11 tripod to 3-1/2 x 8.

#2132-01: Adapts 5/8 x 11 tripod to 1/4 x 20.



## Tripod Laptop Bracket

#5196-02

Use your laptop at the job site! It's easily held on the instrument tripod with this fully-adjustable bracket. Measures 13 x 10.25 in (33 x 26.04 cm)

Weighs 2.2 lb (1.02 kg)



## Tri-Max Tri-Dolly

#90555

The Crain Tri-Dolly™ speeds up data collection and makes moving your instrument setup quick, no need to break down to get to your next measuring location. It's ideal when working on hard surfaces in buildings or plants and will work with all common heavy duty tripods.

The Tri-Dolly opens up flat and provides a wide stance, comparable to a standard setup, for your instrument tripod.

Features include sturdy rubberized 3-inch-tall castor wheels that swivel 360 degrees, quick-lever style steel risers (with rubber boots) for lifting or securing individual legs.

Because the Tri-Dolly uses the same high-quality components as the legendary Tri-Max the center section includes a functional round head with a 5/8 x 11 stud to mount instruments on for low shots or to store battery on. Remove the center stud for jobs requiring plumbing over a point. Sturdy flexible cords loop over each tripod foot plate for added stability. Two legs fold in for convenient storage.

Includes a high-quality polyethylene shipping case for transporting or storage.

Weighs 14.4 lb (6.54 kg)



## Omnidirectional Scanner Target

#6700-Series

An omnidirectional ball or sphere target, for use with laser scanners, is 6 inches round and is made of durable matte-white polyester. The target height is 150 mm and it has a small center groove for measuring the height above the ground point. It's compatible with all standard surveying equipment; tribrachs, poles, etc.

Accessories sold separately include: #6700-050 Quick Disconnect adapter; #8081-00-ORG padded bag, #8130-00-ORG padded bag (which holds target with tribrach and adapter); #2152-04-BLK optical plummet; #2070-00 tribrach adapter; #5507 series 150-mm height poles; #5218 series pole bipod or tripod.

Weighs between 2.43 and 2.87 lb (1.1 and 1.3 kg)



#6700-00  
with female  
5/8 x 11 adapter



#6700-01  
with male  
5/8 x 11 adapter



#6700-02  
with Quick Disconnect  
adapter



# Optical Instruments

The #4811-Series Auto Levels feature a sturdy metal Japanese-style body with a magnetic dampened compensator and 24X or 32X magnification. The top cover plate is easily removed for quick adjustment. It fits 5/8 x 11 flat or domed tripods. A high quality aluminum carrying case is included. It's accurate to 1/16-inch per 100 feet (in good conditions).



<b>Specifications:</b>	<b>#4811-24:</b>	<b>#4811-32:</b>
Magnification	24X	32X
Color	Orange	Orange
Objective Diameter	36 mm	42 mm
Field of View Angle	1° 20'	1° 20'
Shortest Focusing Distance	0.3 m	0.3 m
Stadia Constant	100	100
Additive Constant	0	0
Compensator Range	±15'	±15'
Compensator Setting Accuracy	<0.5"	<0.5"
Double Run Leveling per 1 km	2 mm	2 mm
Circular Vial Accuracy	8/2 mm	8/2 mm
Horizontal Circle	1°	1°
Weight	2.7 lb (1.22 kg)	2.7 lb (1.22 kg)
Base Plate	5/8 x 11	5/8 x 11

Apache auto levels feature 24X or 32X magnification and air-dampened or magnetic-dampened compensators. The removable top cover makes access to the compensator easy. These auto levels are accurate to 1/16-inch per 100 feet (in good weather conditions). Package includes: auto level, allen wrench, pin tool, rain cover, and plumb bob—all within the hard-shell case.

<b>Specifications:</b>	<b>#4812-24A:</b>	<b>#4812-24M:</b>	<b>#4812-32A:</b>
Magnification	24X	24X	32X
Color	Red	Red	Red
Objective Diameter	30 mm	30 mm	36 mm
Field of View Angle	1° 20'	1° 20'	1° 20'
Shortest Focusing Distance	0.6 m	0.6 m	0.6 m
Stadia Constant	100	100	100
Additive Constant	0	0	0
Compensator Dampening	Air	Magnetic	Air
Compensator Range	±15'	±15'	±15'
Compensator Setting Accuracy	<0.5"	<0.5"	<0.5"
Double Run Leveling per 1 km	2 mm	2 mm	1 mm
Circular Vial Accuracy	8/2 mm	8/2 mm	8/2 mm
Horizontal Circle	1°	1°	1°
Weight	3.5 lb (1.6 kg)	3.5 lb (1.6 kg)	3.5 lb (1.6 kg)
Base Plate	5/8 x 11	5/8 x 11	5/8 x 11



## Aluminum Carrying Case

### #4812-CASE

This sturdy aluminum case is designed to carry the 4812 Auto Level models. Purchase this case separately as an option to the stock case.



## Auto Level Packages: the whole kit in one box!

These packages include a 24X auto level, aluminum tripod and an aluminum builder's rod.

### The #4811 Package Includes:

24X Auto Level #4811-24,  
Aluminum Tripod #5301-27-BLK and one of the following Builder's Rods:

- #4811-24P1 — Aluminum Rod #7321-30 (9 ft, in/ft grads)
- #4811-24P2 — Aluminum Rod #7301-30 (9 ft, 10ths/ft grads)
- #4811-24P3 — Aluminum Rod #7341-30 (3 m, 5 mm grads)

Weighs approximately 24 lb (10.9 kg)

### The #4812 Package Includes:

24X Auto Level #4812-24,  
Aluminum Tripod #5301-27-BLK and one of the following Builder's Rods:

- #4812-24AP1 — Aluminum Rod #7321-30 (9 ft, in/ft grads)
- #4812-24AP2 — Aluminum Rod #7301-30 (9 ft, 10ths/ft grads)
- #4812-24AP3 — Aluminum Rod #7341-30 (3 m, 5 mm grads)

Weighs approximately 24 lb (10.9 kg)





## Apache ADT-2 Digital Electronic Theodolite

#4855-00

Designed for general construction applications, the Apache ADT-2 digital electronic theodolite gives you accurate measurements in an affordable, versatile, easy to use platform.

### Apache ADT-2 Specifications

#### Telescope

Image	Erect
Magnification	30X
Aperture	45 mm (1.7 in)
Focus Distance	1.35 m (4.43 ft) to $\infty$
Field of View	1° 30'
Stadia Ratio / Constant	100 / 0

#### Optical Plummet

Image	Erect
Magnification	3X
Angle of View	5°
Focusing Range	0.5 m ~ $\infty$ (1.6 ft ~ $\infty$ )
Reticle Type	Crosshair

#### Angle Measuring System

Minimum Reading	1" or 5"
Precision	2"
Units	Deg / mil / gon / V %
Display	Dual, Large Character, Backlit LCD both sides

#### Tilt Sensor

Automatic Compensation	User set On/Off, $\pm 3'$ Range
------------------------	---------------------------------

#### Vials

Tubular	30"/2 mm
Circular	8'/2 mm

#### Illumination

Display	Yes
Reticle	Yes

#### Other

Dust/Water Resistance	IP-54
Operating Temperature	-20°C to +50°C (-4°F to +122°F)
Size	164 x 154 x 340 mm (6.4 x 6.1 x 13.4 in)
Weight	4.5 kg (9.9 lb)
Shipping Weight	8.6 kg (19 lb)
Warranty	1 year



#4855-10

Add an optional eyepiece for more flexibility.

(Sold separately).



Large backlit LCD display on front and back.



# Direct Elevation Rods

## Ash DE Laser Rods

#7502-21 — Bold Face 10ths/100ths (shown)  
#7602-21 — Cut & Fill 10ths/100ths

The rods extend 10 ft (3 m) and retract to 5.4 ft (1.6 m).

The front features a graduated, endless 10-foot stainless steel band which runs over Delrin® end-rollers.

The latch in the back locks the band in any position.

These come with a side rail for connecting an optional bracket (at right).

Weighs 7 lb (3.2 kg)

*Lenker Style!*



## Ash DE Rods (non laser)

#7502-20 — Bold Face 10ths/100ths (shown)  
#7602-20 — Cut & Fill 10ths/100ths

These rods have the same high-quality features as their counterparts above but without the rail for the detector bracket.



## DE Rod Bag

#8166-01-ORG

This Cordura® bag has a reinforced bottom and a pocket for a sensor bracket. A shoulder strap is included.

4 x 71 in (10.16 x 180.34 cm). Weighs 0.5 lb (0.23 kg)



## Detector Brackets for Laser DE Rods

The high-quality metal brackets below fit the ash/aluminum SECO Laser DE Rods!



### Number: Bracket Designed For:

A	5079-038	Topcon LS-30, LS-50, LS-70, LS-80
B	5079-054	Laser Alignment Rod-Eye 6
C	5079-055	Spectra Physics 1275, Apache 34, 44, Laser Reference R8
D	5079-056	Laser Reference R4, R5, R7
E	5079-057	Laser Alignment Rod-Eye 8, LD 400
F	5079-058	Laser Alignment Rod-Eye Pro, Apache 64
G	5079-059	Spectra Precision HR 500, CR 600
H	5079-068	Spectra Precision HR 550
I	5079-069	Spectra Precision HR 350
J	5079-070	Apache Storm®, Laserometer®, Spectra Precision HL700
K	5079-071	Leica Rod-Eye Basic

## One Shot Cut and Fill Rod

While leveling rods are great for cut and fill applications with large changes in elevation, they require math to calculate the cut or fill measurement. This introduces a large potential for error. Worse yet, most of the time, if the math is wrong, it is off by two times the correct measurement.

The cut or fill measurement on the Crain One Shot® is read directly on the rod. The correct measurement is virtually guaranteed — saving you time and money.

The durable construction of the One Shot means no brittle or easily breakable tapes or parts.

Some typical uses include: grading, masonry, site work, forms, landscaping, foundations, sewers, drainage, and slab work. Includes carrying case.

**CRAIN®**

Number:	Length:	Graduations:	Weight:
94001	8 ft	10ths	4 lb (1.81 kg)
94002	8 ft	inches	4 lb (1.81 kg)
94003	2.4 m	E metric	4 lb (1.81 kg)
94021	13 ft	10ths	5 lb (2.26 kg)
94022	13 ft	inches	5 lb (2.26 kg)
94023	4.0 m	E metric	5 lb (2.26 kg)
94041	16 ft	10ths	7 lb (3.17 kg)
94042	16 ft	inches	7 lb (3.17 kg)
94043	5.0 m	E metric	7 lb (3.17 kg)

## One Shot Carrying Case

#91422 — 8 ft (2.4 m) — Measures: 4.25 x 43 inches (10.8 x 109.2 cm)  
 #91423 — 13 ft (4.0 m) — Measures: 4.25 x 59 inches (10.8 x 149.9 cm)

This case is made from quality 1000-denier nylon and is water-resistant.



One Shot Rod telescopes out to taller heights

Instructions:  
 Locking on line permits direct reading of cut or fill - no math!



Adjust and securely lock One Shot on target elevation.

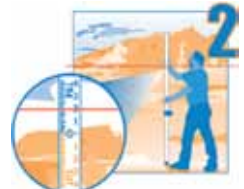

Direct read grades on the scale.

## Lightweight Cut and Fill Rods

#7310-10 — Centimeter and Millimeter Graduations (shown)  
 #7310-11 — Inches and Eighths Graduations  
 #7310-12 — Tenths and Hundredths

These lightweight aluminum Cut and Fill rods make finish grading easy.

The red section is a 'Cut' value from grade with a range of 1 ft 7 in (0.48 m). The clear lower section is a 'Fill' value from grade with a range of 2 ft 2 in (0.66 m).

The rods collapse to 2 ft 8 in (0.81 m) and extend to 6 ft 2 in (1.88 m). End to end the collapsed length is 4 ft 3.50 in (1.31 m).

These feature a graduated telescoping bottom section that locks in place with a durable metal clamp screw. The rods also feature a built-in circular vial.

The sliding laser receiver bracket works with all laser receivers using standard rod clamps. Weighs 1.30 lb (0.59 kg)

Sliding Detector Bracket works with all laser receivers (sold separately) and their standard rod clamps

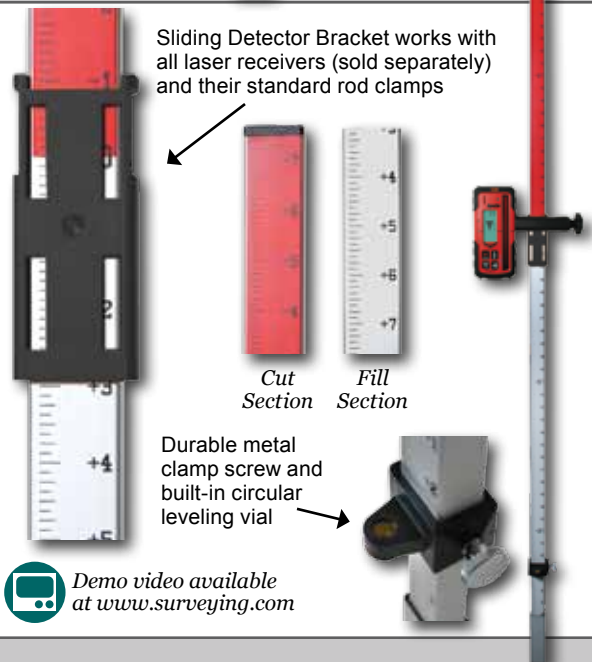

Demo video available at [www.surveying.com](http://www.surveying.com)

# Fiberglass Leveling Rods

## Surveyor's Series Leveling Rods (SVR)

The Crain SVR Leveling Rod features some recent design improvements that keep it on top and still the industry standard! The new sleeker design features a new shorter collapsed length (58.5 inches on 25-foot versions) and a lighter weight.

It's constructed of strong, rigid fiberglass with reinforcing ribs for added stability. It's waterproof and non-conductive. The rectangular-oval shape allows for wide, glare resistant scales that are wear-resistant.

A tight locking mechanism features round buttons that resist jamming from sand and dirt. Features a 1/4 x 20 female adapter in top section.



**CRAIN®**



Rectangular-oval shape allows for wide, glare-resistant scales that are wear-resistant.

Number:	Length:	Graduations:	Weight:	Number:	Length:	Graduations:	Weight:
90343	16 ft	10ths	5 lb (2.27 kg)	98010	25 ft	10ths	6 lb (2.72 kg)
90344	16 ft	inches	5 lb (2.27 kg)	98011	25 ft	inches	6 lb (2.72 kg)
90370	5.0 m	0.5 cm metric	5 lb (2.27 kg)	98012	7.6 m	0.5 cm metric	6 lb (2.72 kg)
90386	5.0 m	'E' metric	5 lb (2.27 kg)	98013	7.6 m	'E' metric	6 lb (2.72 kg)
90388	5.0 m	Philly metric	5 lb (2.27 kg)	98014	7.6 m	Philly metric	6 lb (2.72 kg)
90301*	16 ft (5.0 m)	inches/10ths	5 lb (2.27 kg)	98015*	25 ft (7.6 m)	inches/10ths	6 lb (2.72 kg)
90345*	16 ft (5.0 m)	10ths/Philly metric	5 lb (2.27 kg)	98016*	7.6 m (25 ft)	10ths/Philly metric	6 lb (2.72 kg)
				98017*	25 ft (7.6 m)	10ths/10ths	6 lb (2.72 kg)

\* Dual scale rods.

SVR rods come with a carrying case. The rod case can also be purchased separately. Measures 4.25 x 65.5 in (10.8 x 166.4 cm)

#91411



## SVR Series Laser Brackets

#91100 — Universal Top Mounting Block  
#91120 — Universal Rod Clamp

Brackets are needed to attach laser sensors to the SVR. Universal brackets are available in both the rod clamp and top mount versions.



#91100

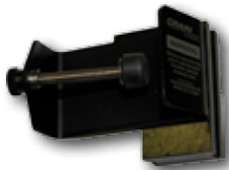

#91120

## SVR Sensor Top Mount Series

Number:	Description:
91108	Topcon LS-03 Top Mount
91110	Laser Alignment Rod-Eye Pro
91111	Trimble® HR500
91116	Apache Lightning 2®
91117	Apache Lightning®
91118	Apache Cyclone®
91162	Apache Storm® Laserometer® HL 700 / 750

## SVR Sensor Rod Clamp Series

Number:	Description:
91121	S-P 1077, LA-4, AGL-4
91128	Topcon LS-30
91129	Spectra Physics 1175 & 1177
91141	Trimble® HR500
91156	Apache Lightning 2®
91163	Apache Storm® Laserometer® HL 700 / 750

## Other Accessories Available

Number:	Product Description:
91014	6-inch Long Caliper for SVR/Oval Rod and CMR Ruler
91255	Snap-Tite® SVR Rod Level
91258	5/8 x 11 Prism Mounting Adapter Kit
91259	Swiss-style Prism Adapter
91275	SVR Hook
91276	SVR Caliper
91535	Snap-Tite® CR Rod Level



## Rectangular Series Leveling Rods (CR)

The CR Series Leveling Rod incorporates many features including a rectangular shape with rounded back corners for better gripping, a scale width graduated to fill the entire face of the rod, and a measuring scale on the back side that allows for overall height readings.

Our leveling rods are made with strong fiberglass, which is waterproof and corrosion-resistant. The CR series is a natural for laser detector mounting with no special brackets required.

The CR series is non-conductive and features a 1/4 x 20 female adapter in the top section. A carrying case is included.

**CRAIN**

Number:	Length:	Graduations:	Weight:
92001	8 ft	10ths	3 lb (1.36 kg)
92002	8 ft	inches	3 lb (1.36 kg)
92021	13 ft	10ths	5 lb (2.26 kg)
92022	13 ft	inches	5 lb (2.26 kg)
92041	16 ft	10ths	6 lb (2.72 kg)
92042	16 ft	inches	6 lb (2.72 kg)
92031	20 ft	10ths	7 lb (3.17 kg)
92032	20 ft	inches	7 lb (3.17 kg)
92003	2.4 m	Philly metric	3 lb (1.36 kg)
92026	4.0 m	E metric	5 lb (2.26 kg)
92027	4.0 m	0.5 cm metric	5 lb (2.26 kg)
92028	4.0 m	British E metric	5 lb (2.26 kg)
92023	4.0 m	Philly metric	5 lb (2.26 kg)
92046	5.0 m	E metric	6 lb (2.72 kg)
92047	5.0 m	0.5 cm metric	6 lb (2.72 kg)
92048	5.0 m	British E metric	6 lb (2.72 kg)
92043	5.0 m	Philly metric	6 lb (2.72 kg)

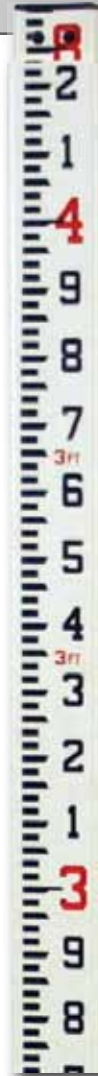

Rectangular shape allows for laser detectors to be mounted directly to the rod - no bracket required!

### CR Carrying Case

#91410  
For 8 ft (2.4 m) rods.  
Measures: 3.5 x 56.5 in (8.9 x 143.5 cm)

#91411  
For 13 ft (4 m), 16 ft (5 m) and 20 ft (6 m) rods.  
Measures: 4.25 x 65.5 in (10.8 x 166.4 cm)

This carrying case is made from the highest quality 1000-denier nylon and is water-resistant.



## Standard Series Leveling Rods (LR)

The LR Series leveling rods are round and easy to handle. The LR-STD is available in a 25-ft model in 10ths, inches, and 0.5-cm metric scales.

The LR-PRO is larger in diameter so sturdier and easier to read.

The LR-PRO leveling rod is available in 25 ft, 35 ft and 45 ft lengths in feet/10ths/100ths. A carrying case is included.

### 5/8 x 11 Double Male Prism Adapter #91133

Adapt the thread size to 5/8 x 11 for mounting prisms on the LR's female adapter.

Weighs 0.20 lb (0.09 kg)



**CRAIN**

Number:	Description:	Length:	Graduations:	Weight:	OD:
90004	LR-STD	25 ft	10ths	5 lb (2.26 kg)	1-5/8-in
90009	LR-STD	25 ft	inches	5 lb (2.26 kg)	1-5/8-in
90014	LR-STD	7.6 m	metric	5 lb (2.26 kg)	1-5/8-in
90022	LR-PRO	25 ft	10ths	7 lb (3.17 kg)	2-in
90024	LR-PRO	35 ft	10ths	9 lb (4.08 kg)	2-3/16-in
90026	LR-PRO	45 ft	10ths	10 lb (4.53 kg)	2-3/16-in



Round design makes the LR Series rods a good choice for certain applications like in areas of high wind.

### LR-STD/LR-PRO Carrying Case

#91402  
Measures: 4.5 x 82 in (11.4 x 208.3 cm)

This carrying case is made from the highest quality 1000-denier nylon and is water-resistant.



# Aluminum Builder's Rods and Accessories

## Aluminum Leveling Rods

SECO aluminum leveling rods are made of a light and durable alloy. The telescopic sections are anodized and silk-screened with moisture-resistant ink. Each rod section uses sturdy polycarbonate buttons that lock each section when extended; the height gauge is on the back side. These rods come in three heights and graduations. Each rod includes a special level and protective bag. Three-piece rods weigh 2.4 lb (1.1 kg); 4-piece rods weigh 3.1 lb (1.4 kg); 5-piece rods weigh 3.5 lb (1.6 kg)

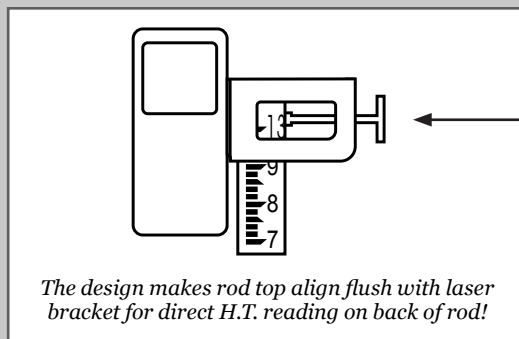

The design makes rod top align flush with laser bracket for direct H.T. reading on back of rod!

Number:	Sections:	Length:	Graduations:
7321-30	3	9 ft, 9.5 in	inches
7301-30	3	9.8 ft	10ths
7341-30	3	3 m	5 mm
7321-40	4	13 ft, 1.38 in	inches
7301-40	4	13.12 ft	10ths
7341-40	4	4 m	5 mm
7321-50	5	16 ft, 4.75 in	inches
7301-50	5	16.4 ft	10ths

## Replacement Rod Button

- #70014-6 — Round - 17 mm
- #70014-7 — Round with Metal Ring - 13 mm

These replacement buttons fit on SECO aluminum leveling rods shown here.



## Leveling Rod Thumb Release Bipod

#5217-21-FOR

This bipod features a special head that will hold a rectangular rod.

The head will fit rods with widths between 1.57 and 2.56 inches!

Weighs approximately 4 lb (1.82 kg)



## 'E' Pattern Builder's Rod

- #7341-31 — 3 meter
- #7341-41 — 4 meter
- #7341-51 — 5 meter
- #7341-52 — 5 meter (16 ft) Dual Scale 'E' pattern / inches and eighths

This rod has a standard 'E' pattern. The grads are in centimeters on the front and numbered every 10 cm (except the #7341-52). The height scale is in millimeters on the back. This rod comes with a level vial and a case.

The lightweight aluminum sections are in contrasting white, red and black colors and have round spring-loaded locking buttons.

#7341-31 weighs 2.4 lb (1.1 kg), #7341-41 weighs 3.1 lb (1.4 kg), #7341-51 weighs 3.5 lb (1.6 kg), #7341-52 weighs 3.25 lb (1.47 kg)

## Leveling Rod Vial

#7321-050

Use with aluminum leveling rods. Weighs 0.5 lb (0.23 kg)



## Invar Rod Thumb Release Bipod

#5217-20-FLY

This bipod features a special head that will hold a rectangular rod. The head will fit rods with widths between 2.95 and 3.54 inches!

Weighs approximately 4 lb (1.82 kg)



## 6.5-Foot Pocket Rod

- #7321-00 — Inches
- #7301-00 — 10ths

This 6.5-foot nylon-coated tape is ideal for foundation work, grading, swimming pools, and construction. Easy-to-read numbers are printed on both sides. The blade also features a built-in target.

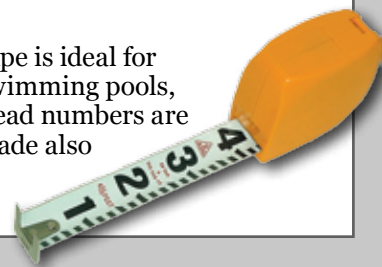

## SubSurface Handheld Magnetic Locators

#ML-1 — Standard Model  
#ML-1M — With LCD Meter

SECO has teamed up with SubSurface Instruments™ to distribute these high-quality magnetic locators. The SubSurface team has the most experience in the industry when it comes to building and servicing high-quality magnetic locators.

The SSI ML-1 and ML-1M both come with an industry exclusive lifetime warranty.

You choose: the standard model or the LCD meter model.

These ferrous metal locators are perfect for locating survey corner markers, PK and Mag Nails, valve and covers, steel and iron pipes, well casings, steel tanks, lost tools or even downed and buried fence lines.

The tube-through construction ensures strength and durability from the bottom tip to the handle.

The system comes with a padded carrying bag and four alkaline 9-volt batteries — two to use and two spares. A hard-shell case for the SSI Locators (shown below) is sold separately.

Weighs less than 2 lb (0.91 kg)



## SubSurface Hard Shell Case for Magnetic Locators

#ML-1-050

Need more protection for your SSI locator? Order the ML-1-050 case. Its impact resistant ABS plastic construction is perfect for storing the locator or for transporting.



# Hand Levels

SECO Hand Levels feature brass bodies, a non-glare internal finish, high-visibility neon yellow vials, and three-line mirrors. The typical accuracy of the SECO Hand Level is 0.25 inch per 20 feet. Don't settle for less, buy the industry's standard hand level.



*Includes padded belt-loop case!*

## #4040-30

This 2X model is a heavy-duty, 5-inch (127-mm) hand level that extends to 7 inches (178 mm). The external vial is easily replaced in the field.

Weighs 0.35 lb (0.16 kg)



*Includes padded belt-loop case!*

## #4040-60

This 1X model is an economically priced hand level. The 5-inch (127-mm) level has an external vial that is easily replaced in the field.

Weighs 0.3 lb (0.14 kg)



*Includes padded belt-loop case!*

## #4040-05

This 5-inch (127-mm) 1X hand level extends to 7 inches (178 mm). The external vial is easily replaced in the field.

Weighs 0.3 lb (0.14 kg)



*Includes padded belt-loop case!*

## #4051-00 (1X Hand Level) #4052-00 (2X Hand Level)

These 5-inch hand levels feature larger diameters, 1-inch lenses, and internal glass vials. Both of these hand levels come with a padded case.

Weighs 0.35 lb (0.15 kg)



*Includes padded belt-loop case!*

## #4300-00

This 2X model is a heavy-duty, 5-inch (127-mm) hand level that extends to 7 inches (178 mm) and has an enclosed vial.

Weighs 0.4 lb (0.18 kg)



*Includes padded belt-loop case!*

## #4200-00

This 2X hand level is the industry standard hand level. This 6 inch (152-mm) level extends to 7 inches (178 mm) and has an enclosed vial.

Weighs 0.4 lb (0.18 kg)



Tech Tips available at [www.surveying.com](http://www.surveying.com)



## #4050-00

This 5.25-inch quick-sighting level is perfect for the handyman. It's ideal for laying bricks, or pavement. It can be used while building retaining walls, or other construction as well.

Weighs 0.10 lb (0.05 kg)

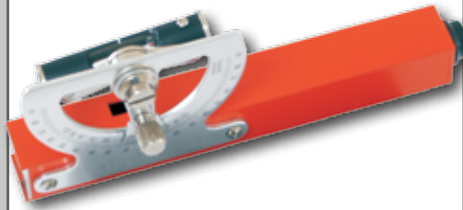

## #4050-01

The Abney Level is ideal for preliminary survey or landscaping, where the determination of slope, angle and percentage of grade is required. Measures 5.25 inches in length.

Weighs 0.15 lb (0.07 kg)



## #8030-00-CABLU

Constructed of padded nylon Cordura®, it's perfect for protecting your hand level when not in use.

Measures 6.5 x 2.62 in (16.5 x 6.66 cm).

Weighs 0.05 lb (0.02 kg)



## PVC-Coated Fiberglass Tapes

The PVC-coated tape features high-tension-resistant fiberglass, encased with two layers of clear PVC! And, the injected fiberglass ribbon's color never wears off!

Number:	Length:	End:	Graduations:
3003-03	200 ft	Hook	ft/in/8ths
3003-05	50 ft	Hook	ft/10ths/100ths
3003-06	100 ft	Hook	ft/10ths/100ths
3003-07	200 ft	Hook	ft/10ths/100ths
3003-08	300 ft	Hook	ft/10ths/100ths
3003-15	100 ft	Hook	ft/in/10ths (Dual Grad)
3003-17	200 ft	Hook	ft/in/10ths (Dual Grad)

## Nylon-Coated Steel Tapes

The 1/2-inch nylon-coated steel tapes are designed for the hardest use, in all kinds of climate conditions. This tape is designed for durability and longevity.

Number:	Length:	End:	Graduations:
3006-03	200 ft	Hook	ft/in/8ths
3006-06	100 ft	Hook	ft/10ths/100ths
3006-07	200 ft	Hook	ft/10ths/100ths
3006-08	300 ft	Hook	ft/10ths/100ths
3006-10	30 m	Hook	m/cm/mm
3006-11	60 m	Hook	m/cm/mm
3006-17	200 ft	Hook	ft/in/10ths
3006-18	200 ft	Hook	10ths/metric



## CMR Series Measuring Ruler

A versatile tool for fast, accurate, one-person measuring, the CMR Series is the tool for measuring heights, clearances and horizontal distances up to fifty feet.

Made of rugged, non-conductive fiberglass and comes with a carrying case and calliper tip. The rod is equipped with a female 1/4 x 20 adapter in the top section.

A carrying case is included.

**CRAIN**

Number:	Length:	Weight:	OD:
90180	25 ft/7.6 m	5 lb (2.27 kg)	1-13/16-in
90181	36 ft/11 m	9 lb (4.08 kg)	2-7/32-in
90182	50 ft/15.2 m	12 lb (5.44 kg)	2-13/32-in



## CMR Series Carrying Cases

- #91415 — 25 ft (4.6 m)  
Measures: 3.5 x 65 in
- #91416 — 36 ft (11 m)  
Measures: 4.5 x 68 in
- #91417 — 50 ft (15.2 m)  
Measures: 4.5 x 68 in

This case is made from the highest quality 1000-denier nylon.

Weights 0.5 lb (0.22 kg)



# Measuring Tapes and Rulers

## Triangular Engineer and Architect Scale Tapes

#9006-00 — Engineer Tape  
#9006-01 — Architect Tape

The Engineer and Architect Scale Tapes are the new standard for scaling plans in the field or office. One of the main problems with triangular rules is they cannot easily be taken out on a job site or carried in your pocket. The Engineer Scale Tape has all of the 10, 20, 30, 40, 50, 60 scales you'd find on a standard Engineer rule. Included in the Architect Scale Tape you'll find the following scales: 16, 3, 1 1/2, 1, 1/2, 1/4, 1/8, 3/4, 3/8, 3/16, 3/32, and 1/16.



## Rhino Ruler Waterproof Fiberglass Engineer's Folding Ruler

#4770-00 — 10ths/Inches  
#4770-01 — 10ths/Metric

Waterproof fiberglass construction prevents common problems that occur with wood rulers such as fading, splintering, and chipping. Engraved graduations resist weather and scratches. Easy-to-fold locking joints are tighter than traditional folding rulers made of wood allowing for a more accurate measurement along the ruler's length.

The Rhino Ruler outlasts wood rulers four to one!



**BASICS+**

## Heavy-Duty Pocket Tape

The heavy-duty power tape features a rubberized black and high visibility yellow case with a positive thumb lock and release action.

Number:	Length:	Graduations:
4769-00	25 ft	10ths
4769-01	25 ft	10ths/metric
4769-02	25 ft	10ths/in
4769-03	33 ft	10ths
4769-04	33 ft	10ths/in
4769-06	33 ft	10ths/metric
4769-12	12 ft	10ths/in
4769-13	12 ft	10ths/metric

## Steel Tape

#4769-10 Inches, 25 ft

Features include a steel, double-coated, one-inch-wide tape blade with a four-rivet hook. The tape has a double-sided stand-up backscale for measuring wall and ceiling heights.



## Stainless Steel Tape

#4769-11 Inches, 25 ft

This tape is similar to the tape above but features stainless steel hook, belt clip and rivets. Get it dirty on the job? Just hose it off!



# ANSI/ISEA Class 3 Safety Utility Vests

## 8365 Class 3 SUV

This SECO vest meets the standards for the **ANSI/ISEA 107-2010 Class 3** specifications.

This vest was developed in conjunction with surveyors from the California Department of Transportation. It is made from durable ANSI/ISEA compliant polyester and polyester mesh.

This vest has YKK zippers. It has 4-inch (10.16 cm) wide reflective tape with 2-inch (5.08 cm) wide silver stripes made with 3M Scotchlite Reflective Material. The padded collar is made with Outlast fabric on the inside. This vest features multiple pockets for cell phone, tapes, radio, pencils, maps, spray cans, etc., plus two inside pockets. It comes with dual mic clips.

The sizes range from S to J.

This vest is available in fluorescent orange and fluorescent yellow.



COOL\_Mesh



## 8390 Class 3 SUV

This new vest meets ANSI/ISEA 107-2010 Class 3 standards for reflectivity.

It's manufactured with tricot and textured Polyester mesh for durability and comfort.

Features include three front outside pockets and a mic clip.

These vests stay cool in the summer heat and are highly visible in low-light conditions

The 8390 has 3-in (7.62 cm) wide reflective tape with 2-in (5.08 cm) wide silver stripes

There are four sizes available (Large, XL, 2X, 3X) in fluorescent orange and yellow.

COOL\_Mesh



# ANSI/ISEA Class 3 Safety Utility Vests

## 8368 Class 3 SUV

This SECO vest meets the standards for the **ANSI/ISEA 107-2010 Class 3** specifications. It's specifically designed for high-speed traffic areas and/or where workers need to be as conspicuous as possible. It features 2-inch-wide retroreflective tape on the fluorescent body and sleeves. The pocket layout is the same as the 8068 SUV.

Other features include convenient pockets with flaps (including the map pocket) for items like pens and pencils, notebooks, a radio and flagging tape.

The durable fluorescent fabric is constructed of 100% texturized polyester for softness, comfort, superior strength, and abrasion resistance. Four sturdy snaps keep the vest closed.

This model is available in fluorescent orange and fluorescent yellow, in sizes from XS to J and is machine-washable.



LARGE MAP POCKET

## 8374 Class 3 Mesh SUV

This SECO mesh vest meets the standard for the **ANSI/ISEA 107-2010 Class 3** specifications.

It features 2-inch wide retroreflective tape on the fluorescent body and sleeves. Its comfortable, relaxed fit is due, in part, to the large neck opening, four high-quality snaps, and the new 70D mesh polyester material.

As with many SECO vests, this one features a radio mic clip, pockets and pen/pencil slots. It also sports 'hand-warmer' pockets, 5 and 6.5-inch deep outer pockets!

This model is available in fluorescent orange and fluorescent yellow, in sizes from XS to J and is machine-washable.



COOL Mesh

## Fitting a SECO Safety Vest

Measure around the fullest part of your chest. Allow room for your work shirt and/or jacket under the vest when measuring — an inch or two is recommended.

Chest Size:	Vest Size:	Vest part number specifics
36 to 38 inch	XS	Example: If you are looking to purchase an 8374 Series vest in size 'Large' in 'fluorescent orange' material, then the correct part number is 8374-50*-FOR**.  *The chest size uses the higher number in the size range (50).  **The color is specified by using FOR for fluorescent orange or FLY for fluorescent yellow.
40 to 42 inch	S	
44 to 46 inch	M	
48 to 50 inch	L	
52 to 54 inch	XL	
56 to 58 inch	2X	
60 to 62 inch	3X	
64 to 66 inch	J	

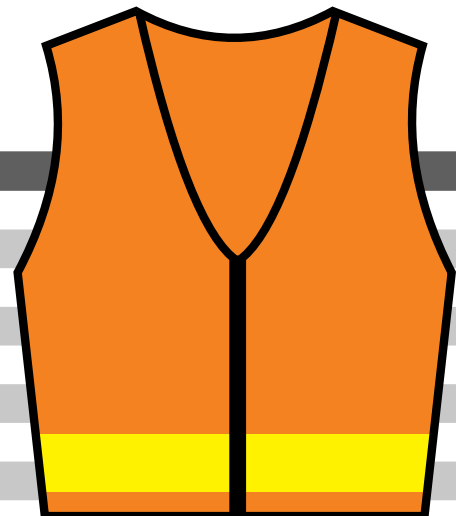

# ANSI/ISEA Class 2 Safety Utility Vests

## 8265 Class 2 Safety Utility Vest with Outlast Adaptive Comfort Collar and Mesh Back

This vest was developed in conjunction with surveyors from the California DOT. It meets **ANSI/ISEA 107-2010 Class 2** federal mandatory requirements.

Safety features include bright fluorescent material, 4-inch (10.16-cm) wide contrasting reflective material with 2-inch (5.08-cm) wide silver stripes made of 3M™ Scotchlite™ reflective material.

This vest is made of durable ANSI/ISEA compliant polyester and polyester mesh. Other high-quality components include brass grommets, heavy-duty webbing and trim, and a genuine YKK™ zipper. The padded collar is made of Outlast® fabric to help regulate body temperature.

Carrying lot's of gear? Not a problem for this vest. It comes with four large pockets on the outside and two generous pockets on the inside. Great for field books, tapes, pencils, flagging, cell phones, etc.

Fold the flap up on the left breast pocket for easy access to pencils and markers. Pen and pencil slots now have a special 'stiffener' sewn in to keep items in place.

Two new spray can holders on the hips of the vest include straps for keeping the cans in place until you need them.

This vest also comes with two convenient mic clips—one above each breast pocket.

Sizes range from S to J. Also available in fluorescent yellow.

 Demo video available at [www.surveying.com](http://www.surveying.com)

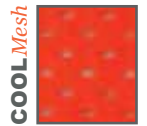

## ANSI/ISEA Class 2 Safety Vest

#8292-XX-FOR — Flo Orange  
#8292-XX-FLY — Flo Yellow

This zippered vest is designed to meet **ANSI/ISEA 107-2010** regulations for safety clothing on job sites.

Safety features include bright fluorescent material and reflective tape.

Sizes range from L to 3X. Also available in fluorescent yellow.



# ANSI/ISEA Class 2 Safety Utility Vests

There is no doubt you will see the SECO 8063, 8069, and 8290 series Safety Utility Vests (SUV) on the job site because they are simply *that* comfortable!

## 8063 Class 2 SUV with Outlast Liner

The 100% polyester 8063 is manufactured to meet **ANSI/ISEA 107-2010 Class 2** standards. Combining the flash of the retroreflective material and the tremendous cargo space gives you the package you're looking for in an SUV! This vest is based on the popular SECO 8068.

### Standard Features of the 8063

**Climate Control:** The 8063 features a comfortable hi-tech liner made of Adaptive Comfort® material by Outlast®, a Certified Space Technology,™ designed to balance temperature.

By storing your excess heat as it's created and releasing it as needed, you won't be too hot or too cold. You'll be comfortable all day. This vest with its Adaptive Comfort liner is destined to change the way you think about safety vests.  
**Cargo Room:** The special compartments include a field notebook pocket, map pocket, pencil slots, compass pocket with grommet, oversized adjustable back compartment, flagging tape pocket with grommets, and inside pockets. There's even an exterior radio mic clip! This model is available in either fluorescent orange or fluorescent yellow, in sizes XS to J.



## 8069 Class 2 SUV with Mesh Back

The 8069 is a 100% polyester SUV manufactured to meet **ANSI/ISEA 107-2010 Class 2** standards. This vest is based on the popular SECO 8068-Series.

### Standard Features of the 8069

**Climate Control:** The 8069 features a cool, comfortable mesh back.

**Cargo Room:** The special compartments include a field notebook pocket, pencil slots, compass pocket with grommet, flagging tape pocket with grommets, and inside pockets. There's an exterior radio mic clip on this model also! This model is available in either fluorescent orange or fluorescent yellow, in sizes XS to J.

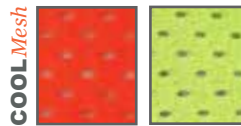

## 8290 Class 2 Mesh Vest

The 8290 series economy vest is manufactured with tricot and textured polyester mesh for durability and comfort. It's also manufactured to meet **ANSI/ISEA 107-2010 Class 2** standards.

### Standard Features of the 8290

This vest features a wide variety of pockets including: radio pocket; pencil pocket; two front outside pockets; two front inside pockets; rear map pocket.

It is made with 3M™ Scotchlite™ Reflective Material. The sizes range from L to 3X. Also available in fluorescent yellow. If you need a cool vest with different reflective tape, this is the vest for you!

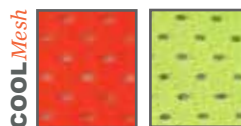

# Standard Series Safety Utility Vests

## 8067-Series Heavy-Duty Safety Utility Vest

The 8067-Series Safety Utility Vest with two-inch-wide reflective tape is highly visible in any weather condition day or night. The vest is made of heavy-duty 1000 denier Cordura.<sup>®</sup>

The material is treated with a durable, water-repellent finish. It also has a urethane backing for additional water-resistance and strength.

Cordura is more durable than cotton, polyester, ordinary nylon, or polypropylene, and has exceptional resistance to punctures and tearing. This vest is available in fluorescent yellow and fluorescent orange and is perfect for jobs away from federal highways but where high visibility is desired. Weighs 1.65 lb (0.72 kg)



Number:	Color:	Chest Size:	Vest Size:
8067-38-FOR	Flo Orange or Yellow	36 to 38 in	XS
8067-42-FOR	Flo Orange or Yellow	40 to 42 in	S
8067-46-FOR	Flo Orange or Yellow	44 to 46 in	M
8067-50-FOR	Flo Orange or Yellow	48 to 50 in	L
8067-54-FOR	Flo Orange or Yellow	52 to 54 in	XL
8067-58-FOR	Flo Orange or Yellow	56 to 58 in	2X
8067-62-FOR	Flo Orange or Yellow	60 to 62 in	3X
8067-66-FOR	Flo Orange or Yellow	64 to 66 in	J

## 8068-Series Lightweight Safety Utility Vest

The 8068-Series Safety Utility Vest offers visibility and safety on the job site.

The durable fluorescent fabric is constructed of 100% polyester for softness, comfort, superior strength, and abrasion resistance.

This vest is designed to comply with **ANSI/ISEA 107-2010 Class 2** standards for high-visibility safety apparel. The vest has two-inch-wide stripes of retroreflective tape. It features convenient pockets with sturdy snap fasteners. Weighs 1 lb (0.45 kg)



Number:	Color:	Chest Size:	Vest Size:
8068-38-FOR	Flo Orange or Yellow	36 to 38 in	XS
8068-42-FOR	Flo Orange or Yellow	40 to 42 in	S
8068-46-FOR	Flo Orange or Yellow	44 to 46 in	M
8068-50-FOR	Flo Orange or Yellow	48 to 50 in	L
8068-54-FOR	Flo Orange or Yellow	52 to 54 in	XL
8068-58-FOR	Flo Orange or Yellow	56 to 58 in	2X
8068-62-FOR	Flo Orange or Yellow	60 to 62 in	3X
8068-66-FOR	Flo Orange or Yellow	64 to 66 in	J

# Safety Vests and Padded Field Cases

## Reflective Economy Nylon Mesh Safety Vest

#8076-01-FLY

This vest features elastic sides and a front Velcro closure.

The lightweight, cool mesh vest fits all sizes.

It has one-inch-wide reflective stripes and is trimmed with a quarter-inch-wide nylon binding.

This model is available in either fluorescent orange or fluorescent yellow.

Weighs 0.27 lb (0.12 kg)

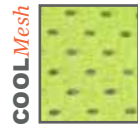

**BASICS+**

## Single Prism Bag

#8070-00-ORG

This bag is heavily padded for single prisms.

Measures: 5 x 7 x 2 in (12.7 x 17.8 x 5.1 cm).\*

Weighs 0.48 lb (0.22 kg)



## Tribrach Case

#8071-00-ORG

Easily holds a tribrach. Measures: 6 x 6 x 2 in (15.2 x 15.2 x 5.1 cm).\*

Weighs 0.40 lb (0.18 kg)



## Triple Prism Bag

#8080-00-ORG

Heavily padded for triple prisms.

Measures: 9 x 7 x 2 in (22.9 x 17.8 x 5.1 cm).\*

Weighs 0.75 lb (0.34 kg)



## Jumbo Triple Prism Bag

#8081-00-ORG

For triple prisms and prism targets or tribrachs. Measures: 10 x 9.5 x 3 in (25.4 x 24.1 x 7.7 cm).\*

Weighs 1.06 lb (0.48 kg)



## Super Jumbo Bag

#8082-00-ORG

Holds a tilting prism with tribrach and adapter. Measures: 12 x 12 x 3 in (30.5 x 30.5 x 7.6 cm).\*

Weighs 1.85 lb (0.84 kg)



## Tall Triple Prism Bag

#8130-00-ORG

Designed for vertical triple prism assemblies.

Measures: 15 x 8 x 2 in (38.1 x 20.3 x 5.1 cm).\*

Weighs 1.45 lb (0.66 kg)



\*Approximate dimensions between the interior foam wall padding.



## Total Station Rucksack

#8120-30-ORG — Holds 400 mm T. Station  
#8120-40-ORG — Holds 500 mm T. Station

The Total Station Rucksack is similar to a lightweight day pack.

The main compartment features an innovative 'wrap' made of 3/8-inch high-density foam with hook and loop adjustment that securely cradles all total stations (400 or 500 mm height).

Also features extra pockets and Rhinotek™ bottom.

The #8120-30-ORG weighs 2.40 lb (1.10 kg)  
The #8120-40-ORG weighs 3.20 lb (1.45 kg)



## Front-Loading Total Station Field Case

#8120-00-ORG

Loads from the front and has a compartment for accessories. Features a Rhinotek bottom and durable backpack straps.

Measures: 14 x 9 x 7 in (35.6 x 22.9 x 17.8 cm).\*

Weighs 5.75 lb (2.61 kg)



## Top-Loading Total Station Field Case

#8121-00-ORG

Loads from the top. Features a Rhinotek bottom and durable backpack straps.

Measures: 14 x 9 x 7 in (35.6 x 22.9 x 17.8 cm).\*

Weighs 5.75 lb (2.61 kg)



## Front-Loading Total Station Case with Frame

#8122-00-ORG

Loads from the front and has a heavy-duty aluminum frame. Features Rhinotek on the bottom. Features backpack straps for easy carrying.

Measures: 14 x 9 x 7 in (35.6 x 22.9 x 17.8 cm)\*

Weighs 7.5 lb (3.4 kg)



## Top-Loading Total Station Field Case with Frame

#8123-00-ORG

Loads from the top and has a heavy-duty frame. Features Rhinotek on the bottom. Features backpack straps for easy carrying.

Measures: 14 x 9 x 7 in (35.6 x 22.9 x 17.8 cm)\*

Weighs 7.5 lb (3.4 kg)



\*Approximate dimensions between the interior foam wall padding.

# Padded Field Cases

## Robotics Backpack

#8134-00-GRN — Fluorescent Green

Designed for robotics, this pack features a double-zipped, top-loading station compartment lined with rigid foam padding, two side pockets for cables, and one front battery pocket. It has a top rain flap with closure and rain flaps on the side pockets. The free-standing aluminum frame keeps the pack upright even when fully loaded. It has a comfortable padded belt with our new lumbar back support system, shoulder straps with all-point adjustment features, and a rubberized carrying handle. For safety, the pack has 1.5-inch yellow reflective stripes on all sides. Also features a Rhinotek™ bottom.

Interior dimensions\*:

17 x 10 x 10 inches (43.2 x 25.4 x 25.4 cm)

Exterior dimensions:

24.5 x 15 x 16 inches (62.2 x 38.1 x 40.7 cm)

Weighs 8 lb (3.62 kg) and holds 40 lb (18.14 kg)



## Large GIS Backpack with Antenna Bar

#8125-00-ORG — Orange

This pack, which includes mesh and foam back pad, offers a convenient and comfortable way to transport and manage GIS instrumentation. Also features a pocket for CamelBak® or other hydration systems and protective rain flap.

### Large GIS Backpack with Cam-Lock Antenna Pole

#8125-11-ORG - Orange

This pack is the same as above, but with a cam-lock antenna pole instead of a bar.

These packs are made of heavy-duty, high-vis polyester. The packs have adjustable internal pockets; padded, adjustable shoulder straps, and waist belt.

Interior dimensions\*: 20 x 9.5 x 4 inches (50.8 x 24.2 x 10.2 cm)

Weighs 2.8 lb (1.27 kg)

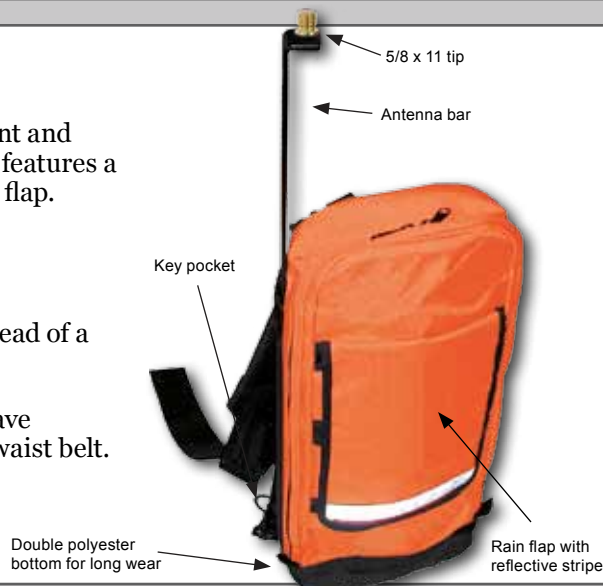

## Small GIS Backpack

#8125-50-ORG — Orange

This pack includes a cam-lock antenna pole; adjustable straps; several interior pockets; belt loop straps; a rain flap, and much more.

Interior dimensions\*: 15 x 9 x 4 inches (38.1 x 22.86 x 10.16 cm)

Weighs 2 lb (0.91 kg)

### Cam-Lock Antenna Pole

#5139-01

The pole extends from 16.5-to-36.5 inches (41.91 to 92.71 cm).

Rain flap with reflective tape opens to several interior pockets



## GPS Backpack

#8124-00-ORG — Orange

This pack features a heavy-duty freestanding aluminum frame with twist locking antenna pole extensions.

It includes three adjustable internal pockets, two side and two bottom egress openings for cables, and four cable straps. It also has adjustable pockets in three sizes.

Interior dimensions\*: 17.5 x 14.75 x 3.75 inches (44.45 x 37.47 x 9.53 cm)

Weighs 6.3 lb (2.86 kg)



\*Approximate dimensions between the foam wall padding.

## Heavy-Duty Bag for 18-inch (46.72-cm) Stakes or Rebar

#8090-20-ORG

The main compartment of this bag is constructed of tough Rhinotek™ material and designed to hold 18-inch stakes or rebar. Other features include a hammer loop, an adjustable strap and brass grommet drain holes at both ends of the bag.

Weighs 1.55 lb (0.70 kg)

## Heavy-Duty Bag with Center Partition

#8091-20-ORG

This stake bag is the same as above but features a partition down the middle of the bag for separating stakes and hubs.

Weighs 1.70 lb (0.77 kg)



## Heavy-Duty Bag for 24-Inch (60.96-cm) Stakes or Rebar

#8092-20-ORG — Single compartment (shown)

#8096-20 — Split compartment with center partition

This stake bag is the same as the #8090-20-ORG above, but holds 24-inch stakes. Features a Rhinotek bottom. Weighs 1.70 lb (0.77 kg)



## Heavy-Duty Bag for Lath or Rebar

#8100-20-ORG — 8 ID x 34 inches (20.3 ID x 86.4 cm)

#8101-20-ORG — 8 ID x 46 inches (20.3 ID x 116.9 cm)

These two are similar to the popular SECO #8100-00-ORG Lath Bag but with the addition of Rhinotek material on the bottom and six inches up the sides.

Both weigh approximately 1.50 lb (0.68 kg)



## Surveyor's Tool Pouch with Belt

#8046-30-ORG

The Surveyor's Tool Pouch features a 9 x 2 x 11-inch (22.9 x 5.1 x 27.9-cm) pocket with two vent grommets. The large pocket is lined with two layers of 1000D Cordura®. A smaller pocket on the front is made of durable Rhinotek. Other features include a hammer loop and marker storage. The webbed belt adjusts to a 50-inch (127-cm) waist.

Weighs 1.05 lb (0.48 kg)



## Heavy-Duty Prism Pole Tripod Bag

#8180-20-ORG — 7.5 ID x 60 inches (19.1 ID x 152 cm)

This bag is designed to carry a prism pole with the tripod attached. The bag has a fold-over flap and is made from nylon Cordura and durable Rhinotek.

Weighs 1.55 lb (0.70 kg)



## Heavy-Duty Instrument Tripod Bag

#8150-20-ORG

This heavy-duty bag holds all major brands of aluminum or wood tripods. It's made of heavy-duty nylon Cordura and Rhinotek. It features pull string ties at the top.

Weighs 1.85 lb (0.84 kg)



# Bags and Cases

## Heavy-Duty Lath Carrier

#8102-01-ORG

Hold up to 50 lath or rebar! It's constructed of Cordura®, leather and Rhinotek™ materials. Now includes a nail pocket! Measures 9 x 38 inches (2.54 x 96.52 cm).

Weights 0.22 lb (0.10 kg)



## Lath Carrier

#8102-00-ORG — Orange

The carrier measures 33 inches (84 cm) long with two handle straps. Carries up to 50 lath.

Weights 1.46 lb (0.66 kg)



## Lath Bag

#8100-00-ORG — 8 ID x 34 inches (20.3 ID x 86.4 cm)  
#8101-00-ORG — 8 ID x 46 inches (20.3 ID x 116.9 cm)

Holds 36 or 48-inch (84 or 122-cm) wood lath. Features a hand loop, shoulder strap, and outside pocket.

Weights 0.8 lb (0.36 kg)



## Lath Bag

#8103-00-ORG — Standard Lath Bag  
#8103-20-ORG — With Rhinotek (shown)

Holds 24-inch (61-cm) wood lath. It has a hand loop, a shoulder strap, and an outside pocket. It features an 8-inch diameter.

Weights 0.4 lb (0.18 kg)



## Wire Stake Flag Bags

#8093-00-ORG — For 21-inch Flags (shown)  
#8094-00-ORG — For 30-inch Flags

Use to carry 21-inch (53-cm) or 30-inch (76-cm) flags.

#8093-00-ORG weighs 0.22 lb (0.10 kg)  
#8094-00-ORG weighs 0.28 lb (0.13 kg)



## Map Holster

#8083-00-ORG

The 3-inch (7.6-cm) diameter opening is held open. It's 18 inches (46 cm) long and made from heavy-duty nylon Cordura with leather bottom.

Weights 0.75 lb (0.34 kg)



## Pole Case for Pathfinder

#8143-21-YEL

This case holds the Trimble® Pathfinder® ProXH™ or the ProXT™ GPS unit securely.

Weights 0.45 lb (0.20 kg)



## Cell Phone Pole Case

#8143-20-FLY

This case holds all popular cell phones. This setup is used with GPS systems using GSM phone links. Interior Dimensions: 4 x 2.5 x 1.5 inches.

Weights 0.35 lb (0.16 kg)



## Cell Phone Pole Case

#8143-22-FLY

The case secures your cell phone to any survey pole without slipping! Inside dimensions: 5 x 2.5 x 1.5 inches (12.7 x 6.35 x 3.81 cm).

Weights 0.10 lb (0.45 kg)



## Battery Pole Case

#8015-01-FLY

Carry a camcorder battery as an alternative power source for RTK setups!

Interior Dimensions: 6.5 x 2.5 x 1 inches.  
Weights 0.30 lb (0.13 kg)



## Case for Recon w/CF Cap

#8240-10-ORG — For flash cap  
#8240-00-ORG — Without flash cap (shown)

This Cordura case is designed for the TDS™ Recon® with compact flash cap installed. Inside dimensions: 1 x 3.25 x 9 in (2.5 x 8.3 x 22.9 cm).

Weights 0.20 lb (0.09 kg)



## Construction-Style Tool Pouch

#8046-20-ORG — Orange

Features include an 11 x 7-inch (28 x 18-cm) and 6 x 4-inch (15 x 10-cm) pouches.

It has slots for markers, a loop for axes or hammers.



## Bag for 18-inch (46-cm) Wood Stakes

#8090-00-ORG

For 18-inch (46-cm) stakes and rebar. Measures: 19 x 8 x 12 in (48.3 x 20.3 x 30.4 cm).

Weighs 0.78 lb (0.35 kg)



## Bag for 24-inch (61-cm) Wood Stakes

#8092-00-ORG

For 24-inch (61-cm) stakes and rebar. Measures: 25 x 8 x 12 in (63.5 x 20.3 x 30.5 cm).

Weighs 0.95 lb (0.43 kg)



## Bag for 18-inch (46-cm) Wood Stakes

#8091-00-ORG

Same as above but with center partition to separate stakes and hubs.

Weighs 0.88 lb (0.40 kg)



## Bag for 24-inch (61-cm) Wood Stakes

#8096-00-ORG

Same as above but with center partition to separate stakes and hubs.

Weighs 1.10 lb (0.50 kg)



## Monster Gear Bag

#8106-10-ORG

Need more room for tools, clothes, or other gear? This bag measures 30 x 14 x 20 in (76 x 36 x 51 cm).

Weighs 3.4 lb (1.54 kg)



## Gear Bag

#8106-20-ORG

Excellent for carrying surveying gear. Made of heavy-duty water resistant polyester and Rhinotek™. Measures 27 x 11 x 11 in (69 x 28 x 28 cm). Weighs 1.56 lb (0.71 kg)



## Collapsible Bucket Bag

#8095-20-ORG

Features include an outside pocket with a Velcro closure and 2-inch straps made with heavy-duty webbing. It has a Rhinotek and leather reinforced bottom.

Measures 10.25 x 15 inches (26 x 38 cm).

Weighs 1.3 lb (0.59 kg)



## Heavy-Duty Bucket Bag

#8095-50-RED

This heavy-duty, water-resistant bucket bag is reinforced at all the wear points. Plenty of pockets!

Weighs 1.6 lb (0.73 kg)



## Heavy-Duty Bucket Lath Carrier

#8104-20-ORG



Demo video available at [www.surveying.com](http://www.surveying.com)

This heavy-duty lath carrier holds any standard 12-inch, five-gallon bucket.

Weighs 1.5 lb (0.68 kg) without bucket and approximately 3.85 lb (1.75 kg) with bucket.



## Spray Can Holder

#8098-00-ORG - Standard Holder

#8098-10-ORG - With Accessory Pockets (shown)

Choose between a standard spray can holder or a holder with updated features like four pockets for pens/pencils and a heavy web strap.



Demo video available at [www.surveying.com](http://www.surveying.com)



## Flagging Dispenser

#8025-00-ORG

Holds four rolls of flagging! Includes a belt strap.



Demo video available at [www.surveying.com](http://www.surveying.com)



# Paint and Marking Supplies

## Aervoe Survey Marking Paint

Aervoe's Survey Marking Paint is a superior upside down marking paint that is designed for survey marking. It provides the best quality paint in terms of color visibility and retention, durability, and a lasting mark of up to six months. Non-freezing and operational to 14° F. Colors formulated to meet standards set by OSHA and APWA/One Call Systems.

Aervoe marking paint is designed to be used with the Spot Marker or Marking Stick (shown below) or can be used by hand. Use for survey marking, landscape, utility location, construction and proposed excavation. 20 oz aerosol cans (17 oz net)



Number:	Quantity:	Color:	Case Weights:
9020-01	12 cans per case	Flo Orange	18 lb (8.16 kg)
9020-02	12 cans per case	Flo Pink	18 lb (8.16 kg)

## Aervoe Marking Stick

#9020-10

Aervoe's Marking Stick is constructed of tough, durable materials for easy single-hand operation. Intended for upside down marking only. Weighs 2 lb (0.91 kg)



## Aervoe Spot Marker

#9020-11

This simple, hand held marking gun provides accuracy and control for either upright or upside down marking.

Weighs 1 lb (0.45 kg)



## Dixon Redimark Marker

#9060-06 — Red, 12 count  
#9060-14 — Black, 12 count

The Dixon® Redimark® six-inch metal barrel permanent marker is leak-proof with a seamless metal body. Heavy-duty chisel felt-tip with anchored nib construction. Marks are extremely durable on wood, metal, and more. AP certified non-toxic. Box weighs 3.75 lb (1.70 kg)



## Ideal-Mark Valve Action Markers

#9063-06 — Red, 12 count  
#9063-14 — Black, 12 count

### Replacement Tips

#9064-01 — Bullet Tip, 12 count  
#9064-02 — Chisel Tip, 12 count

Ideal-Mark® permanent marking pens are legendary for their performance and are an excellent value. Features include a leak-proof aluminum valve, pocket clip and color-coded cap.



## Dixon Lumber Crayons

#9061-02 — Flo Pink, 12 count  
#9061-03 — Yellow, 12 count  
#9061-04 — White, 12 count  
#9061-05 — Blue, 12 count  
#9061-06 — Red, 12 count  
#9061-14 — Black, 12 count

Dixon® Lumber Crayons are great for marking steel, concrete, stone, lumber, etc.

Box weighs 3 lb (1.36 kg)



## Dixon Wood Crayon Holder

#9062-00

The high quality Wood Crayon Holder can accommodate both crayons and markers for increased convenience. It can hold a crayon or marker that is up to 0.5-inch diameter and holds both round and hexagonal shapes. The walnut Crayon Holder has a metal chuck and a wrist strap hole for increased durability and functionality. Weighs 0.5 lb (0.23 kg)



## Automatic Center Punches and Utility Scriber

#9068-02 — Heavy-Duty Center Punch  
#9068-03 — Carbide Scriber

Lightweight aluminum center punches are great for marking a variety of materials or punching starter holes for nails or drill bits.

Durable removable-tip scribers are perfect for making quick and accurate marks on hard work pieces. They work well on metal, ceramic, concrete, stone, lumber or other surfaces. The scriber features a durable tungsten carbide point that is able to make precise marks to 1/100th of an inch. The magnetic cap quickly cleans up stray metal shavings.



# Stake Flags, Flagging Tape and Whiskers

## Presco 100 Count Stake Flag Bundle

These biodegradable stake flags are made of a new superior formula. Presco PVC marking flags resist breaking under high wind conditions and extreme cold. Two flag sizes and two wire length options are available in regular or PresGlo colors.

Number:	Flag Size:	Wire:	Color:
9030-01	2 x 3 inch	21 inch	Orange Glo
9030-02	2 x 3 inch	21 inch	Pink Glo
9030-03	2 x 3 inch	21 inch	Yellow
9030-04	2 x 3 inch	21 inch	White
9031-01	2 x 3 inch	30 inch	Orange Glo
9031-02	2 x 3 inch	30 inch	Pink Glo
9031-03	2 x 3 inch	30 inch	Yellow
9031-04	2 x 3 inch	30 inch	White
9031-06	2 x 3 inch	30 inch	Red
9035-01	4 x 5 inch	21 inch	Orange Glo
9035-02	4 x 5 inch	21 inch	Pink Glo
9035-03	4 x 5 inch	21 inch	Yellow
9035-04	4 x 5 inch	21 inch	White
9035-05	4 x 5 inch	21 inch	Blue
9035-06	4 x 5 inch	21 inch	Red
9035-07	4 x 5 inch	21 inch	Blue Glo
9035-11	4 x 5 inch	21 inch	Orange
9035-12	4 x 5 inch	21 inch	Red Glo
9035-13	4 x 5 inch	21 inch	Yellow Glo
9036-01	4 x 5 inch	30 inch	Orange Glo
9036-02	4 x 5 inch	30 inch	Pink Glo
9036-03	4 x 5 inch	30 inch	Yellow
9036-04	4 x 5 inch	30 inch	White
9036-05	4 x 5 inch	30 inch	Blue
9036-06	4 x 5 inch	30 inch	Red
9036-07	4 x 5 inch	30 inch	Blue Glo
9036-08	4 x 5 inch	30 inch	Green
9036-09	4 x 5 inch	30 inch	Green Glo
9036-10	4 x 5 inch	30 inch	Lime Glo
9036-11	4 x 5 inch	30 inch	Orange
9036-12	4 x 5 inch	30 inch	Red Glo
9036-13	4 x 5 inch	30 inch	Yellow Glo
9037-01	4 x 5 inch	36 inch	Orange Glo
9037-02	4 x 5 inch	36 inch	Pink Glo
9037-03	4 x 5 inch	36 inch	Yellow
9037-05	4 x 5 inch	36 inch	Blue

*100 flags per bundle!*

## Presco Roll Flagging

Presco long-lasting outdoor flagging comes in 5 lb boxes of 12 rolls.

Number:	Color:	Length:
9040-01	Orange Glo	150 ft
9040-02	Pink Glo	150 ft
9040-03	Yellow	300 ft
9040-04	White	300 ft
9040-05	Blue	300 ft
9040-06	Red	300 ft
9040-07	Blue Glo	150 ft
9040-08	Green	300 ft
9040-09	Green Glo	150 ft
9040-10	Lime Glo	150 ft
9040-11	Orange	300 ft
9040-12	Red Glo	150 ft
9040-13	Yellow Glo	150 ft
9040-14	Black	300 ft
9040-15	Pink	300 ft
9040-16	Purple	300 ft



## Flagging Tape Dispenser

#9040-20

The Presco Roll Flagging Belt Dispenser is a convenient time-saver. It is made of durable anodized steel.

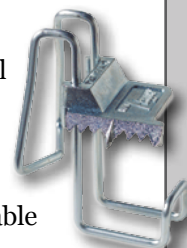

Weights 1.3 lb (0.59 kg)

## Presco Marking Whiskers

Presco 6-inch Marking Whiskers™ are an alternative marking choice for survey and construction sites, underground utility locating and many other uses. Whiskers come in a bundle of 25 each.

Number:	Color:	Weights:
9050-02	Pink Glo	0.3 lb (0.14 kg)
9050-04	White	0.3 lb (0.14 kg)
9050-05	Blue	0.3 lb (0.14 kg)
9050-06	Red	0.3 lb (0.14 kg)
9050-08	Green	0.3 lb (0.14 kg)
9050-11	Orange	0.3 lb (0.14 kg)



Use with 60-Penny nail or a wood stake!

## Presco Aerial Flagging

For aerial mapping and surveying jobs requiring a perimeter for photos.

Number:	Color:	Size:	Weights:
9045-01	White	300 ft x 12 in	4.90 lb (2.22 kg)
9045-02	White	300 ft x 18 in	7.36 lb (3.34 kg)
9045-03	White	300 ft x 24 in	7.70 lb (3.49 kg)
9045-04	White	300 ft x 36 in	14 lb (6.35 kg)



## Camper's Axe with Sheath

#9070-00

Estwing's Camper's Axe is forged in one piece steel and features the exclusive Nylon Shock Reduction Grip®. It comes with an embossed leather sheath.

Cutting edge:  
4 inches (102 mm)

Overall length:  
16 inches (406 mm)

Weighs 2.90 lb (1.32 kg)

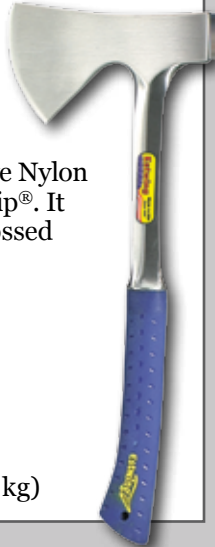

## Rigger's Axe

#9070-01

Estwing's Rigger's Axe is forged in one piece steel and features the exclusive Nylon Shock Reduction Grip®. It has a hammer head on one side and cutting edge on the other.

Cutting edge:  
3.5 inches (89 mm)

Overall length:  
16.75 inches (426 mm)

Weighs 3 lb (1.36 kg)

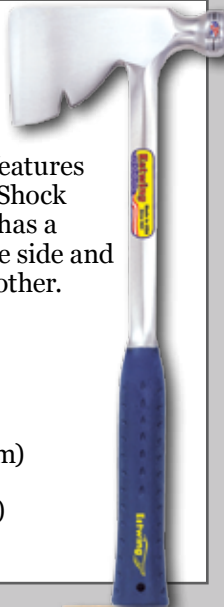

## Long Handle Rock Pick

#9070-02

The 22 oz Long Handle Rock Pick has a bonded and molded Shock Reduction Grip® which offers the utmost in both comfort and durability, while reducing vibrations caused by impact. The head and handle are forged in one piece and have a fully polished head.

Overall length:  
16.5 inches (419 mm)

Weighs 2.3 lb (1.04 kg)

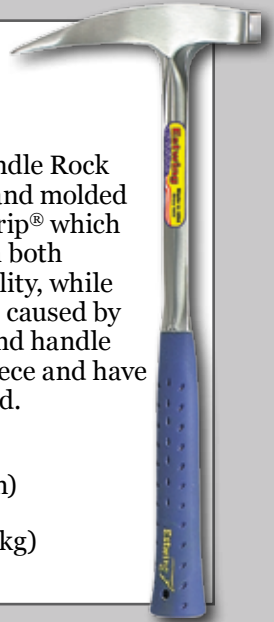

## Rock Pick

#9070-03

Estwing Rock Picks have bonded and molded Shock Reduction Grip® which offers the utmost in both comfort and durability, while reducing vibrations caused by impact. The head and handle are forged in one piece and have a fully polished head.

Overall length:  
13 inches (330 mm)

Weighs 2 lb (0.91 kg)



## Leather Pick Sheath

#9070-04

Estwing Sheath for Pointed Tip and Chisel Edge Picks. Constructed of genuine leather.



## Clear Safety Goggles

#9070-09

Estwing's Safety Goggles feature large ventilated vinyl frames that can be worn over glasses.



## Milled Face Framing Hammer

#9070-05

Estwing's Solid Steel Framing Hammer has a long handle for more striking power. The head and handle are fully polished and forged in one piece. Our exclusive Shock Reduction Grip® is molded on and offers the utmost in both comfort and durability, while reducing vibrations caused by impact.

Overall length:  
16 inches (406 mm)

Weighs 2.38 lb (1.08 kg)

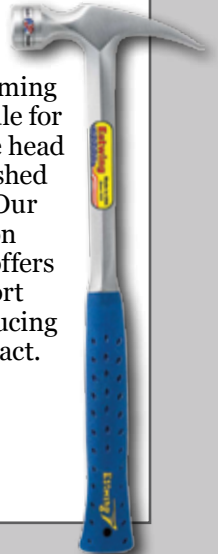

## Drilling Hammer

#9070-06

The Drilling Hammer has a bonded and molded Shock Reduction Grip® which offers the utmost in both comfort and durability, while reducing vibrations caused by impact. The head and handle are forged in one piece, both faces are fully polished.

Overall length:  
11.5 inches (292 mm)

Weighs 4 lb (1.80 kg)



## Rock Chisel

#9070-07

The The Estwing Rock Chisel features a vinyl grip for comfort and durability.

Overall length:  
12 inches (305 mm)

Cut Point:  
0.625 inch

Stock:  
0.375 inch

Weighs 0.97 lb (0.44 kg)



## Engineer's Hammer

#9070-08

The Engineer's Hammer has a bonded and molded Shock Reduction Grip® which offers the utmost in both comfort and durability, while reducing vibrations caused by impact. The head and handle are forged in one piece, and have an attractive blue UV coating, both faces are fully polished.

Overall Length:  
16 inches (406 mm)

Weighs 48 oz (1.34 kg)





## Bound Books

#9090-00 — Transit Pattern

#9091-00 — Level Pattern

Rite in the Rain bound books ensure that your valuable data won't be lost. These all-weather books have 160 pages (80 sheets), including a title and contents page.

This 4<sup>3</sup>/<sub>4</sub> x 7<sup>1</sup>/<sub>2</sub>-inch yellow field book also features a sewn binding.

Weighs 0.65 lb (0.29 kg)

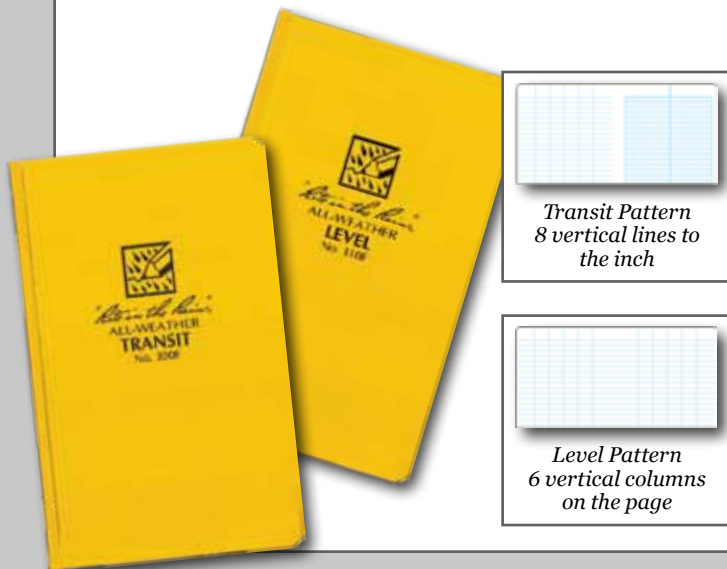

Transit Pattern  
8 vertical lines to  
the inch

Level Pattern  
6 vertical columns  
on the page

## Field Ring Binder

#9092-00

Rite in the Rain Field Ring Binders are extremely durable.

Made with Polydura and rust resistant metals, the binder is designed to fit the 4<sup>5</sup>/<sub>8</sub> x 7-inch standard size loose leaf sheets below (sold separately).

Weighs 0.30 lb  
(0.14 kg)



## Transit Pattern Loose Leaf Sheets

#9092-01 — 100 Sheet Pack

Tough, durable and weather-proof, these Rite in the Rain Loose Leaf sheets are perfect for recording data that will be filed or reorganized. Sold in packs of 100 sheets. Use with Field Ring Binder (above).

Measures:  
4<sup>5</sup>/<sub>8</sub> x 7-inches

Weighs 0.55 lb  
(0.25 kg)



## Level Pattern Loose Leaf Sheets

#9092-02 — 100 Sheet Pack

Sold in packs of 100 sheets, this loose leaf pack has the same features as the Transit Pattern Loose Leaf Sheets (left) except for the page design. This pack features the Level pattern. Use with Field Ring Binder (above).

Measures:  
4<sup>5</sup>/<sub>8</sub> x 7-inches

Weighs 0.55 lb  
(0.25 kg)



# Miscellaneous Field Accessories

## Solid Brass Plumb Bobs

#6000-Series  
#6000-001 — Bob Cap  
#6000-002 — Bob Point

Available weights: 12 oz (340 g), 14 oz (397 g), 16 oz (454 g), 18 oz (510 g), 24 oz (680 g), 32 oz (907 g)



## Gopher Pole Wire Installation Tool

#90520

Installing wires across ceiling spans is made much easier with this unique fiberglass pole. Extends to 22 feet!



## Leather Sheaths

#6000-120 — 10-12 oz (283-340 g)  
#6000-160 — 14-18 oz (397-454 g)  
#6000-240 — 24-32 oz (510-907 g)

The heavy-duty sheath is double stitched top grain leather with a belt loop for SECO bobs (above).



## Shot Bags (paperweights)

#8010-00 — Vinyl  
#8010-10-BLU — Cordura®

Shot bags are great for holding down maps or blueprints in windy conditions. Weighs 1.5 lb (0.68 kg)



## Gammon Reel

#6001-06 — 7 ft (2 m)  
#6001-12 — 12 ft (3.7 m)

The Gammon Reel® is almost a given on any job site. The 24-yard refillable cord comes in many colors.



## Paper Targets

#9000-01 — With holes, 100 count  
#9000-02 — Sticky, 25 count

Use the paper targets with a #50 survey nail or stick the target to just about anything. Measures 2 x 3.5 inches.



## Tac Ball

#2180-00 — Regular Tac Ball  
#2180-01 — Tac Ball with Clip

Pin cushion for holding stake tacks!



## Machetes

#9500-17 — 17.5-inch blade, includes sheath  
#9500-13 — 13-inch blade, includes sheath

Choose between a 17.5-inch blade and a 13-inch blade for clearing that thick underbrush on the job site. Weighs approx. 1 lb (0.45 kg)



## Double Right-Angle Prism

#4900-00

This prism allows for easy determination of right angle points or perpendicular points between two targets.



## Marking Pins

#2183-00 — 11 count

The 3/16-inch spring steel, 14-inch pins are powder-painted red and white, alternating at each inch. Quiver (#8041-00-ORG) sold separately. Weighs 1.54 lb (0.70 kg)

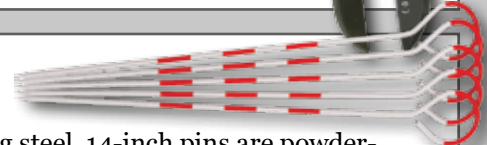

## Knife and Axe Sharpeners

#9500-01 — For knives and scissors  
#9500-02 — For hand tools

The #9500-01 is for knives and scissors.

Weighs 0.05 lb (0.02 kg)

The #9500-02 is for Axes or other edged tools like Pulaskis and machetes.

Weighs 0.20 lb (0.09 kg)



#9500-01



#9500-02

## Shiners

#2181-00 — Flat, 250 count, 2.6 lb (1.18 kg)  
Weighs 2.6 lb (1.18 kg)  
#2182-00 — Raised, 260 count, 1 lb (0.45 kg)  
Weighs 1 lb (0.45 kg)

#2181-00 is 2.25-inches (57-mm) OD.

#2182-00 is 1.94-inches (33-mm) OD.



## Bulk Shiners

#2181-10 — Flat  
#2182-10 — Raised

10 lb of Shiners with included bag.

#2181-10  
approximate  
qty: 1,125

#2182-10  
approximate  
qty: 1,300

Weighs 10 lb  
(4.53 kg)



Continued from page 2.

## Optical Instruments

Auto Level Packages: the whole kit in one box! .....	56
Aluminum Carrying Case .....	56
Apache ADT-2 Digital Electronic Theodolite .....	57

## Direct Elevation Rods

Ash/Aluminum DE Laser Rods .....	58
Ash/Aluminum DE Rods (non laser) .....	58
DE Rod Bag .....	58
Detector Brackets for Laser DE Rods .....	58

## Cut and Fill Rods

One Shot Cut and Fill Rod .....	59
One Shot Carrying Case .....	59
Lightweight Cut and Fill Rods .....	59

## Fiberglass Leveling Rods

Surveyor's Series Leveling Rods (SVR) .....	60
SVR Series Laser Brackets .....	60
Other Accessories Available .....	60
SVR Sensor Top Mount Series .....	60
SVR Sensor Rod Clamp Series .....	60
Rectangular Series Leveling Rods (CR) .....	61
Standard Series Leveling Rods (LR) .....	61
CR Carrying Case .....	61
LR-STD/LR-PRO Carrying Case .....	61

## Builder's Rods and Accessories

Aluminum Leveling Rods .....	62
Leveling Rod Thumb Release Bipod .....	62
Invar Rod Thumb Release Bipod .....	62
'E' Pattern Builder's Rod .....	62
Leveling Rod Vial .....	62
Replacement Rod Button .....	62
6.5-Foot Pocket Rod .....	62

## Magnetic Locators

SubSurface Handheld Magnetic Locators .....	63
SubSurface Hard Shell Case for Magnetic Locators .....	63

## Hand Levels

1X and 2X Hand Levels .....	64
-----------------------------	----

## Measuring Tapes and Rulers

PVC-Coated Fiberglass Tapes .....	65
Nylon-Coated Steel Tapes .....	65
CMR Series Measuring Ruler .....	65
CMR Series Carrying Cases .....	65
Triangular Engineer and Architect Scale Tapes .....	66
Rhino Ruler Waterproof Fiberglass Engineer's Folding Ruler .....	66
Heavy-Duty Pocket Tape .....	66
Steel Tape .....	66
Stainless Steel Tape .....	66

## ANSI/ISEA Class 3 Safety Vests

8365 Class 3 SUV .....	67
8390 Class 3 SUV .....	67
8368 Class 3 SUV .....	68

8374 Class 3 Mesh SUV .....	68
Fitting a SECO Safety Vest .....	68

## ANSI/ISEA Class 2 Safety Vests

8265 Class 2 Safety Utility Vest with Outlast Adaptive Comfort Collar and Mesh Back .....	69
ANSI/ISEA Class 2 Safety Vest .....	69
8063 Class 2 SUV with Outlast Liner .....	70
8069 Class 2 SUV with Mesh Back .....	70
8290 Class 2 Mesh Vest .....	70

## Standard Series Safety Utility Vests

8067-Series Heavy-Duty Safety Utility Vest .....	71
8068-Series Lightweight Safety Utility Vest .....	71

## Safety Vests and Padded Cases

Reflective Economy Nylon Mesh Safety Vest .....	72
Single Prism Bag .....	72
Jumbo Triple Prism Bag .....	72
Tribrach Case .....	72
Super Jumbo Bag .....	72
Triple Prism Bag .....	72
Tall Triple Prism Bag .....	72

## Padded Field Cases and Bags

Total Station Rucksack .....	73
Front-Loading Total Station Case with Frame .....	73
Front-Loading Total Station Field Case .....	73
Top-Loading Total Station Field Case with Frame .....	73

Top-Loading Total Station Field Case .....	73
Robotics Backpack .....	74
Large GIS Backpack with Antenna Bar .....	74
Small GIS Backpack .....	74
GPS Backpack .....	74

Heavy-Duty Bag for 18-inch (46.72-cm) Stakes or Rebar .....	75
Heavy-Duty Bag with Center Partition .....	75
Heavy-Duty Bag for 24-Inch (60.96-cm) Stakes or Rebar .....	75

Heavy-Duty Bag for Lath or Rebar .....	75
Surveyor's Tool Pouch with Belt .....	75
Heavy-Duty Prism Pole Tripod Bag .....	75
Heavy-Duty Instrument Tripod Bag .....	75
Heavy-Duty Lath Carrier .....	76

Lath Bag .....	76
Wire Stake Flag Bags .....	76
Cell Phone Pole Case .....	76
Pole Case for Pathfinder .....	76
Case for Recon w/CF Cap .....	76
Lath Carrier .....	76
Lath Bag .....	76
Map Holster .....	76
Cell Phone Pole Case .....	76
Battery Pole Case .....	76
Construction-Style Tool Pouch .....	76
Bag for 18-inch (46-cm) Wood Stakes .....	77
Bag for 18-inch (46-cm) Wood Stakes .....	77
Monster Gear Bag .....	77
Collapsible Bucket Bag .....	77
Spray Can Holder .....	77

Bag for 24-inch (61-cm) Wood Stakes .....	77
Bag for 24-inch (61-cm) Wood Stakes .....	77
Gear Bag .....	77
Heavy-Duty Bucket Bag .....	77
Heavy-Duty Bucket Lath Carrier .....	77
Flagging Dispenser .....	77

## Paint and Marking Supplies

Aervoe Survey Marking Paint .....	78
Aervoe Marking Stick .....	78
Dixon Redimark Marker .....	78
Ideal-Mark Valve Action Markers .....	78
Dixon Lumber Crayons .....	78
Dixon Wood Crayon Holder .....	78
Aervoe Spot Marker .....	78
Automatic Center Punches and Utility Scriber .....	78

## Stake Flags, Flagging Tape and Whiskers

Presco 100 Count Stake Flag Bundle .....	79
Presco Roll Flagging .....	79
Presco Marking Whiskers .....	79
Presco Aerial Flagging .....	79
Flagging Tape Dispenser .....	79

## Hand and Field Tools

Camper's Axe with Sheath .....	80
Rock Pick .....	80
Drilling Hammer .....	80
Rigger's Axe .....	80
Leather Pick Sheath .....	80
Clear Safety Goggles .....	80
Rock Chisel .....	80
Long Handle Rock Pick .....	80
Milled Face Framing Hammer .....	80
Engineer's Hammer .....	80

## Field Books and Loose Sheets

Bound Books .....	81
Transit Pattern Loose Leaf Sheets .....	81
Field Ring Binder .....	81
Level Pattern Loose Leaf Sheets .....	81

## Miscellaneous Field Accessories

Solid Brass Plumb Bobs .....	82
Leather Sheaths .....	82
Gammon Reel .....	82
Tac Ball .....	82
Double Right-Angle Prism .....	82
Knife and Axe Sharpeners .....	82
Shiners .....	82
Gopher Pole Wire Installation Tool .....	82
Shot Bags (paperweights) .....	82
Paper Targets .....	82
Machetes .....	82
Marking Pins .....	82
Bulk Shiners .....	82



## SECO Media Center

In the Media Center at [surveying.com](http://surveying.com) you can watch dozens of SECO Product Videos and Video Tech Tips.

In the product videos section you will get an up-close look at SECO products with in-depth information brought to you directly from the people behind these innovations.

Learn the fastest way to setup a SECO GPS Tripod or how to maintain your Quick Release Prism Pole.

You will also see what's coming next from SECO.

Just look for the video icons above and visit the Media Center at [surveying.com](http://surveying.com) to experience the growing list of SECO video clips.

